



duplex

DS-12

2.4GHz & 900MHz NG

Dual Band System

FW 5.xx

EN

duplex 

- 1. Introduction** 09
 - 1.1 DS-12 09
 - 1.2 Activation method for software modules of JETI model 09
 - 1.3 Features 11
 - 1.4 Manual Navigation 12
 - 1.5 Technical Support 12
 - 1.6 DS-12 Package Contents 13
- 2. System Specifications** 13
- 3. Help mode** 14
- 4. Description of Transmitter DS-12** 15
 - 4.1 Control Identification 15
 - 4.2 Assembly Identification 16
 - 4.3 Control Stick Assembly 17
 - 4.3.1 Control Stick Length Adjustment 17
 - 4.3.2 Control Stick Angle Adjustment 17

- 4.3.3 Control Stick Tension Adjustment 17
- 4.3.4 Ratchet Tension Adjustment 18
- 4.3.5 Throttle stick travel adjustment 19
- 4.3.6 Changing the transmitter mode 19
- 4.4 Swappable and Assignable Switches 21
 - 4.4.1 Switch Removal Procedure 21
 - 4.4.2 Assembly Procedure 22
- 4.5 Digital Trims 23
- 4.6 Transmitter Battery Pack 23
 - 4.6.1 Charging 23
 - 4.6.2 Battery Replacement 24
- 4.7 PPM Output Connector 24
- 4.8 Handling 25
- 4.9 Change SD Card 25
- 5. RF Transmitter Modules** 26

- 6. Transmitter Powering ON/OFF** 28
 - 6.1 Transmitter, Powering-ON 28
 - 6.2 Transmitter Turning-OFF 28
 - 6.3 Transmitter Restart 28
- 7. Initial switching-on** 29
 - 7.1 Main display 29
 - 7.2 Navigation in the Menu 30
 - 7.2.1 Navigation 30
 - 7.2.2 Browsing through the Menu 31
 - 7.2.3 Basic Menu Structure 31
 - 7.3 Model Set-up Guide 32
 - 7.3.1 Airplane 32
 - 7.3.2 Helicopter 34
 - 7.3.3 Multicopter 36
 - 7.3.4 General 38
 - 7.3.5 Set up of Receiver Outputs 41
- 8. Duplex Receivers** 42
 - 8.1 Description 42

- 8.2 Installation 42
- 8.3 Binding 42
 - 8.3.1 Standard pairing procedure 42
 - 8.3.2 Alternative pairing procedure through the transmitter menu 43
- 8.4 Range test 43
- 8.5 Fail safe 43
- 8.6 Using Device Explorer To Configure the Receiver 45
 - 8.6.1 Support of remote commands for EX Bus devices 48
- 8.7 RC-Switch 50
- 9. Transmitter to PC Connection** 52
 - 9.1 Memory & System Files 52
 - 9.2 Update Firmware 52
 - 9.3 Sounds, Alarms & Acoustic Updates 52
 - 9.4 System Backup 53
 - 9.5 PC Joystick 53
 - 9.6 Telemetry Data Logging 53
 - 9.7 Copying models between the transmitters 53

10. Battery Safety Handling Rules 133

 10.1 Transmitter Battery Pack 133

 10.2 General Safety Rules 133

 10.3 Flight Safety Check 134

 10.4 Application 134

 10.5 FCC/IC Information 134

The following chapters are only included in the electronic version of the manual. The complete manual is available on the SD card of your transmitter or on site www.jetimodel.com.



duplex

lex 

duplex

lex 

duplex

lex 

1 Introduction

1.1 DS-12

The DS-12 transmitter was developed and produced with the cooperation of professional engineers and world champion pilots. The design goals were maximum utility, durability, and reliability of their mechanical parts along with simple handling. The straightforward case shape makes servicing easy. The plastic, ball bearing equipped, control gimbals with their magnetic Hall sensors are another revolutionary design concept used to make the DS-12 among the world's most advanced R/C systems.

Purposefully placed at the top of the transmitter, the 3.5" sunlight readable color LCD with its wide viewing angle offers nearly perfect visibility in just about any lighting condition. Thanks to its high resolution display and use of a relatively large number of graphic images it was possible to create a simple and intuitive setup procedure for displaying telemetric data.

The DUPLEX EX family of products have been equipped with an improved real-time telemetry system which can be viewed on the LCD transmitter display. The transmitter allows the setup of voice notifications, both preinstalled and user created, which can be related to telemetric values, user set alarms, or signals which have been assigned to conditions of various control elements.

The DS-12 offers concept of individual feature setup based upon the requirements of each customer. The transmitter is available in a basic configuration that will meet the needs of most users for most model types. For individual setting of the transmitter there is a configurator available at swshop.jetimodel.com. After the simple registration of your transmitter it is possible to select additional features based upon your individual demands.

1.2 Activation method for software modules of JETI model

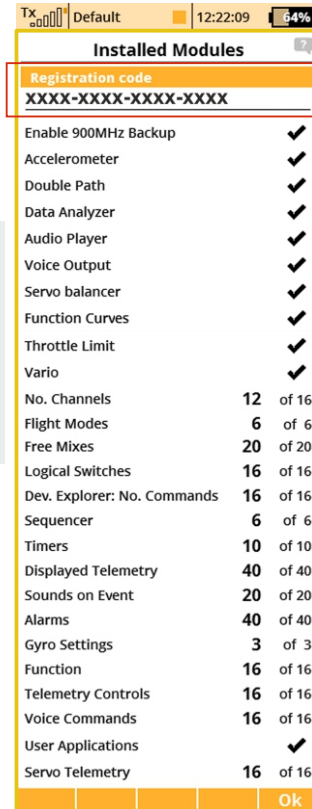

1. Make sure you have the most current firmware version in your transmitter.

2. Register on the site swshop.jetimodel.com.

3. After clicking on the „Register new product“ button you will be redirected to a form where you enter a product type (**DS-14**), followed by the „serial number“ (**SN: xxxxxxxxxx**) (to be found on the back of the transmitter behind the screen) and then enter the „16 digit registration code“ (**xxxx-xxxx-xxxx-xxxx**) (see the menu „System -> Installed Modules“ highlighted by the frame). After registering your transmitter, you can select individual function modules that you want to activate.

4. Mark selected modules and proceed to checkout.

5. Then you will be asked to pay

the relevant amount. After payment, a unique nontransferable file named **“Activation.bin”** will be generated. It will then be sent to your e-mail.

6. Connect the DS-14 to your computer and enable USB mode.

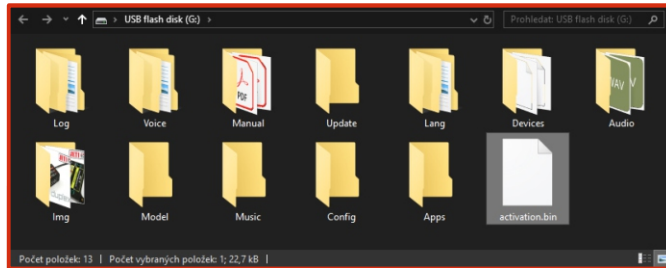

7. Copy the **“Activation.bin”** file to the transmitter SD card into the root folder. The contents of the transmitter SD card can then look like this:

8. Disconnect the transmitter from the computer (Do not forget to confirm the safe hardware removal). Then confirm in your transmitter that you want to update and restart it.

If the activation is successful, an informative table with a list of modules appears immediately after switching on. Then it is possible to operate the transmitter as usual.

1.3 Features

Duplex 2.4GHz – the DS-12 transmitters feature the Duplex 2.4GHz, frequency hopping, digital, data stream system, originally developed by JETI model in the Czech Republic. This system has been reliably used for many years.

Duplex 900MHz NG (Next Generation) - the DS-12 transmitters feature a backup wireless system for unmatched data transmission safety and reliability.

Built-in Telemetry – from the start, the DS-12 transmitters were designed and built with many attractive features and include the full integration of all Duplex telemetry sensors.

Transmitters - the DS-12 designs use premium quality materials and emphasize state-of-the-art appearance and user comfort.

Precise Gimbals – the transmitter gimbals are equipped with Hall sensors and ball bearings for precision movement with an almost unlimited lifespan.

Haptic feedback - the transmitter are equipped with shaking vibration motor that can be used for alarm notifications, timers etc.

LCD Display – color 3.5" TFT LCD display with 320 x 240 resolution which is highly visible under any light conditions.

Li-Ion Battery – provides a proven and reliable energy source with a high capacity (6200mAh) and a long service life.

Easy Charging – simply connect the wall power supply, optional car charger, or any 12V DC power supply to the transmitters charge port. The DS-12 may also be charged through the USB to PC interface. The charging progress is shown on the DS-12 display.

Integrated Antenna – the antennas are located behind fully

integrated cover in the DS-12 case for protection against mechanical damage.

Large Memory – Internal SD card for storing models, sounds, and telemetry data.

USB Connector – convenient connection to your PC. Fast firmware & sound upgrades, telemetry data downloads.

Fast Navigation – 3D wheel-style interface combined with function keys allow for speedy navigation within the DS-12 menu.

Digital Trims – fully programmable trims and a revolutionary automatic trimming function.

Swappable and Assignable Switches – all of the switches on the DS-12 transmitters (2 or 3-position) can be easily moved and assigned to create a custom configuration that works best for your application.

Programming – the logical and intuitive transmitter firmware is designed to be simple to use. Just follow the step-by-step screens. The creation of a new model can be accomplished with just a few easy steps.

Sounds/Alarms – the DS-12 transmitters are equipped with audible alarms and also allows the use of user-recordable alarms and sounds to keep you fully informed while also keeping distractions to a minimum.

Integrated microphone with voice recognition capability - using the integrated microphone you can easily prepare your own audio files. Furthermore, you can teach the transmitter to respond to several voice commands.

1.4 Manual Navigation

Important parts of the instructions are separated from the text and highlighted according to importance.

Advice

Note

Warning

Advanced modelers may want to begin with group 3 where you will get all of the basic information for model setup. This is the quickest way to understand the basic ideas of the DS-12 transmitter programming and with this basic information you can begin to create your own model. More advanced programming functions are found in group 4. This is where you can find detailed descriptions of all of the DS-12 functions. The last section provides detailed description of firmware upgrades, downloads, and special mixes.

1.5 Technical Support

If you feel uncertain about how to set up particular transmitter functions, do not hesitate to take advantage of our technical support:

1. Web Site

Either the JETI model (manufacturer) or your local distributor's web sites offer a wide range of support for the DS-12 transmitters. You will find advice, tips or frequently asked questions (FAQ) which, in most cases, contain the answers to your questions.

2. Distributor, Manufacturer

You may also find support at your local hobby shop, distributor, or directly with the manufacturer JETI model s.r.o.

3. Service and Warranty Coverage

JETI model CZ exclusively warranties that the products purchased will be free from defects in materials and workmanship for a period of 24 months from the date of purchase by the customer. This warranty covers only those products purchased from an authorized JETI model CZ distributor or dealer. Third party transactions are not covered by this warranty. Proof of purchase is required for warranty claims. Repair or replacement decisions are at the sole discretion of JETI model CZ or an authorized service provider. This warranty does not cover cosmetic damage or damage due to an accident, misuse, abuse, negligence, commercial or research use, or modification of or to any part of the product. This warranty does not cover damage due to improper installation, operation, maintenance, or attempted repair by anyone other than JETI model CZ or an authorized service provider.

JETI model CZ reserves the right to change or modify this warranty without notice and disclaims all other warranties, expressed or implied.

1.6 DS-12 Package Contents

1. JETI DS-12 Transmitter, 2. Wall Power Supply, 3. USB PC Cable, 4. Installation Key Set (HEX 1,5; TORX 10), 5. Cleaning Cloth, Instruction Manuals,



2 System Specifications

Basic technical parameter	DS-12
RF module 900MHz (863-870 MHz - EU) (902-928 MHz - US)	○
Stick material Multimode	Plastic
Resolution of sticks	4096
Sticks HALL sensors	●
Internal memory, SD cart	8 GB
RF modul 2.4 GHz	1
Number of antennas	3
LCD	3,5" 320x240px color high contrast
Weight [kg]	0.7
Dimensions [mm]	194x215x55
Battery pack [mAh]	Power Ion 6200

○ Extension ● Contains

3 Help mode

It is possible to call up the help mode for each item where a "question mark" icon appears in the upper right corner of the screen (1). If you see this icon, you can press the "menu" button briefly to call up the help mode for the current item you have highlighted in the respective transmitter menu (1).

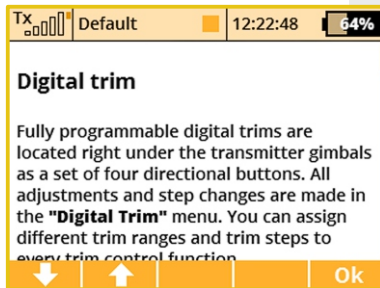
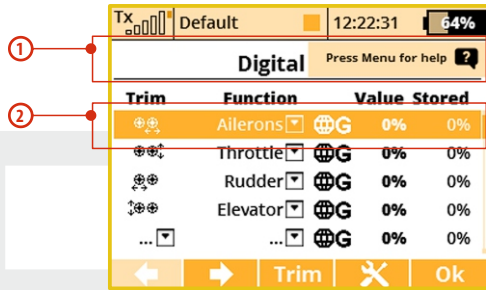

This help mode is available in FW min. v5.00. We recommend update your transmitter by Jeti Studio.

4 Description of Transmitter DS-12



4.1 Control Identification DS-12

1. Right Stick 1, 2 – the DS-12 Transmitter Supports Modes 1-4, see **Control Sticks** -> **mode change**
2. Left Stick 3, 4 the DS-12 Transmitter Supports Modes 1-4, see **Control Sticks** -> **mode change**
3. Swappable and Assignable Switches: Sa, Sb, Sc, Sd, Se, Sf
4. Digital Trims for the Left Stick T3, T4
5. Digital Trims for the Right Stick T1, T2
6. Right Rotary Control Knob 5
7. Left Rotary Control Knob 6
8. Rotary Control Knob 7
9. Rotary Control Knob 8
10. LCD Display
11. Function Buttons F1 – F5
12. Transmitter On/Off Power Switch
13. 3D Control Selector
14. Menu Button
15. ESC Button
16. Shows the 2.4GHz Antenna but NOT the handle.
17. Charge Jack
18. USB PC Interface
19. PPM Input/Output
20. ON/OFF & Charging LED Indicators
21. Speaker
22. Neckstrap Hook
23. Earphone Jack
24. 900 MHz Antenna
25. Microphone

4.2 Assembly Identification

- 26. Battery Connector
- 27. Transmitter Battery Pack
- 28. PPM Output Connector
- 29. Left Gimbal Assembly
- 30. Right Gimbal Assembly
- 31. MicroSD Card
- 32. 2.4GHz Antennas
- 33. 900 MHz Antenna

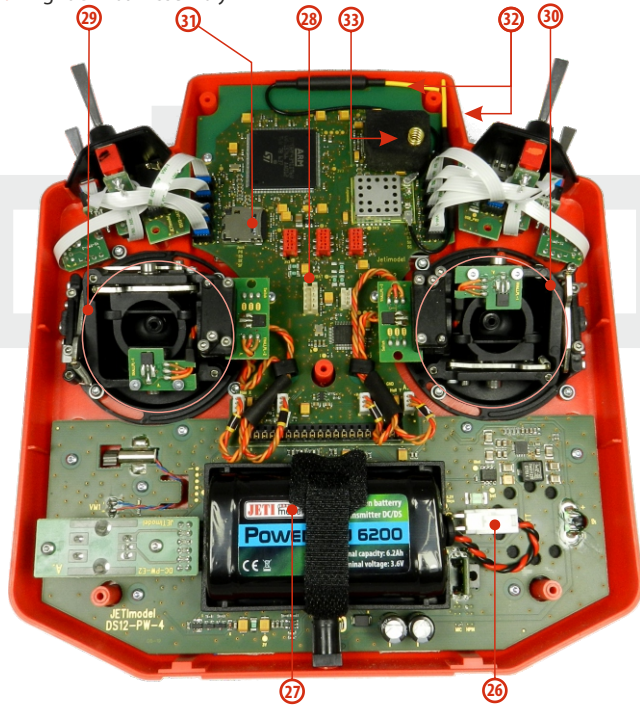

4.3 Control Stick Assembly

Note: When handling with back cover removed always switch off the transmitter and disconnect the battery (unplug the connector). Also do not connect the charging adapter or the USB cable.

Warning: Restrict your contact with the printed circuit boards to a minimum. You can damage your radio by electrostatic discharge!



4.3.1 Control Stick Length Adjustment

The stick length is adjustable to suit your flying style. The stick end separates into two parts.

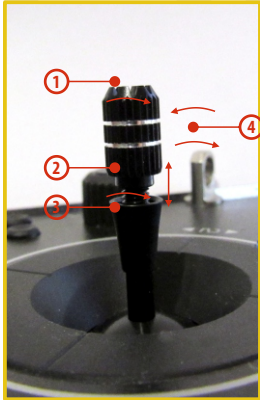

1. Hold the top part of the stick and firmly and unscrew (turn it anticlockwise).
2. Turn the stick end clockwise to shorten or counterclockwise to lengthen the overall stick length.
3. Adjust the lower part to support the top part of the stick end.
4. Finally secure by tightening both parts to each other.

Warning: If you have installed optional sticks with switch or button ends; make sure that while adjusting the stick length you observe the wires that pass through the stick shaft and through the gimbal opening in order to prevent damaging the connecting cables. The safest method is to remove the small set-screw from the side of the stick housing to allow the switch or knob internals to remain stationary while you rotate the stick housing for height adjustment. (4.3.7)

4.3.2 Control Stick Angle Adjustment

It isn't possible to adjust the angle of rotation of control stick in the DS-12 transmitter.

4.3.3 Control Stick Tension Adjustment

The stick gimbal tension is fully adjustable for each axis. This allows you to fully customize your radio's control feel. Simply adjust each gimbal's spring to your desired tension.

1. Switch off the transmitter and remove the 7 screws that secure the radio back cover. Next, remove the radio back cover.

Be sure to disconnect the transmitter battery pack connector.



2. Use indicated machine adjustment screws to change the **desired spring** tension. By turning the screw **counterclockwise, you will loosen** spring tension. As a result the moving resistance of the control stick will **decrease**.

By turning the screw **clockwise, you will tighten** spring tension. As a result the moving resistance of the control stick will **increase**.

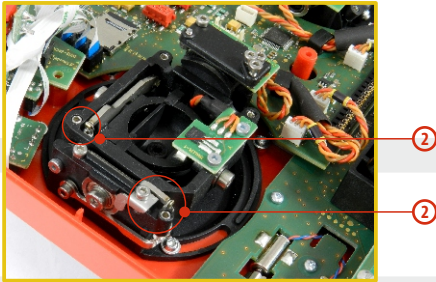

3. Reconnect transmitter battery pack and reinstall radio back cover and cover screws.

4.3.4 Ratchet Tension Adjustment

Whether you prefer smooth throttle feel or ratchet throttle feel, you can adjust the DS-12 transmitter either way you like allowing you to fully customize your radio's feel. Each tension is set by a different machine screw.

1. Switch off the transmitter and remove the 7 screws that secure the radio back cover. Next, remove the radio back cover. **Be sure to disconnect the transmitter battery pack connector.**

2. **For ratchet tension adjustment use the machine screw "A". Turn slowly (counterclockwise)** until you achieve the desired ratchet tension. For smooth tension adjustment, use the machine screw **"B". Turn slowly (clockwise)** until you achieve the desired smooth tension.

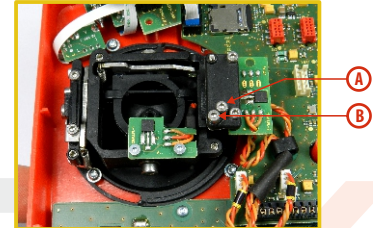

3. Reconnect transmitter battery pack and reinstall radio back cover and cover screws.

4.3.5 Throttle stick travel adjustment

The throttle stick travel is adjustable to suit your flying style.

1. Switch off the transmitter and remove the 8 screws that secure the radio back cover. Next, remove the radio back cover. Be sure to disconnect the transmitter battery pack connector.
2. Use indicated machine adjustment screws to limit the throttle stick travel. By turning the screw clockwise, you will shorten the throttle stick travel.
3. Reconnect transmitter battery pack and reinstall radio back cover and cover screws.

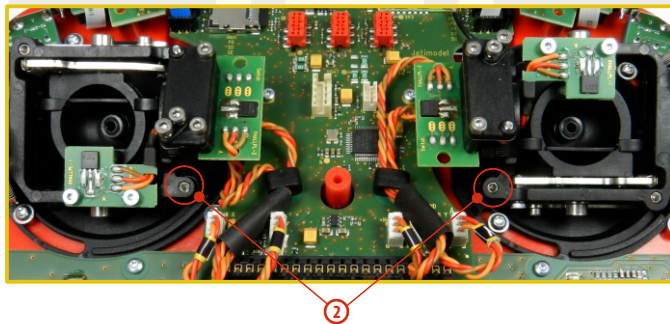

After making a limit change to the throttle stick travel you must recalibrate the transmitter stick in the software menu, **see section 9.6.3 – Calibration of Proportional Controls.**

4.3.6 Changing the transmitter mode

The transmitter is equipped with universal multimode gimbals. Both gimbals are identical and can be adjusted mechanically for modes 1-5. After mechanical adjustment it is necessary to set a specific transmitter mode in the menu System – Configuration – Stick mode 1-4.

To change the quad sticks settings, unscrew the back cover of the transmitter and disconnect the battery connector.

A. Setting the multi-mode gimbal into the mode without locking the middle position - gas

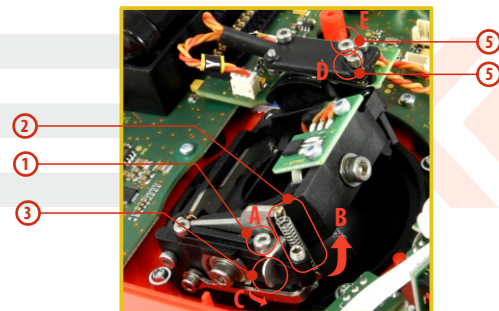

1. Loosen the screw **A**.
2. Lift the lever **B** so as it is possible to arrest the lock **C**.
3. Turn the lock **C** 90° in the direction of the arrow and arrest the lever **B** in the upper position.
4. Tighten the screw **A**.
5. Tightening the the screws **D** and **E** sets the desired tension with steps and smooth brake.

B. Setting the multi-mode gimbal into the mode with locking the middle position - elevator

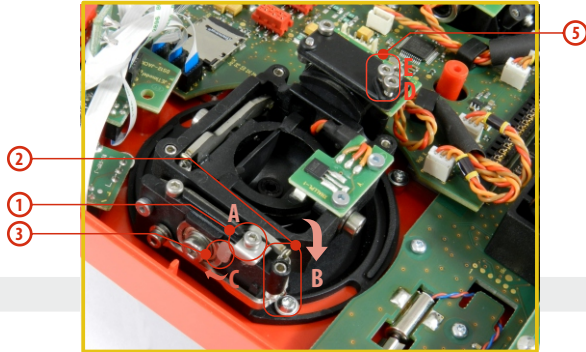

1. Loosen the screw **A**.
2. Slightly lift the lever **B**.
3. Turn the lock **C** in the direction of the arrow and arrest the lever **B** in the upper position.
4. Move the lever **C** in the direction of the arrow to release the lever **B**.
5. Tighten the screw **A**.
6. Loosen the screws E and D in a position so that tension is removed from the stick.

4.4 Swappable and Assignable Switches

One of the most important features of a JETI transmitter is the switch function assignment flexibility. The exact type of switch can be set in „*menu->advanced->properties->sticks-switches->setup*“. There are many switches available to suit different needs. See your Jeti retailer for switch availability.

You may either swap the existing switches around or take advantage of the optional accessories and create your own custom configuration.

Factory Switch Configuration for the DS-12 Transmitter

Sa - 3 - position short switch

Sb - 2 - position long switch

Sc - 2 - position long switch

Sd - 2 - position long switch

Se - 3 - position long switch

Sf - 2 - position short switch

4.4.1 Switch Removal Procedure

1. Switch off the transmitter and remove the 7 screws that secure the radio back cover. Next, remove the radio back cover.
Be sure to disconnect the transmitter battery pack connector.
2. With the specialized wrench (not included) carefully loosen and remove the switch installation nut.



3. Hold the switch from the back side of the transmitter and pull it towards you, so that the switch is released from the body of transmitter.

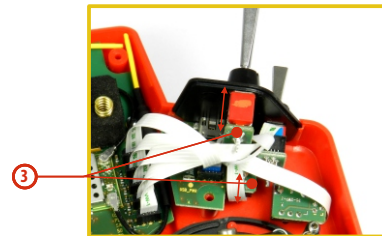

4. Disconnect the flat flexible cable from its connector on the main board.

The flat flexible cables that link the main printed circuit board with the switches are oriented as shown in the picture (4a).

The wire is always color coded on one side of both ends (4b).

The markings must be oriented as shown below.

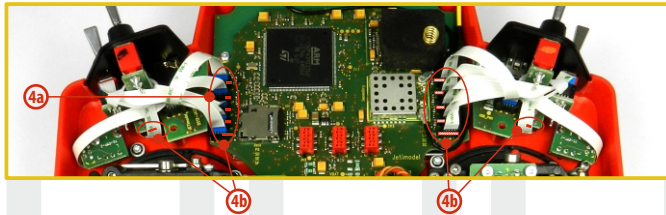

4.4.2 Assembly Procedure

1. Insert the flat flexible cable to the switch connector of the switch. See the orientation above.
2. Push the switch into its spot in the transmitter housing.
3. Tighten the switch installation nut from the front of the transmitter. Use the specialized wrench (not included).
4. Connect the flat flexible cable to the main printed circuit board of the transmitter. See the orientation above. The cable has to be inserted to the connector that matches the position on the front panel where the switch is installed.
5. Reconnect transmitter battery pack and reinstall radio back cover and cover screws.

After you turn on the transmitter for the first time after any switches have been modified, you will notice that the configuration for a selected model no longer matches.

Note: When replacing the switch *Sb* it is also necessary to remove the switches *Sa* and *Sc* from the transmitter body.

When replacing the switch *Se* it is also necessary to remove the switches *Sd* and *Sf* from the transmitter body.

4.5 Digital Trims

Transmitter gimbals are used for controlling the basic flight functions like throttle, roll(aileron), pitch(elevator), and yaw(rudder). Immediately under the transmitter gimbal sticks you can see four push-buttons which are the programmable, digital trim buttons.



The digital trims are used for fine trimming of the flying model. When the transmitter is turned off, the trim values are stored in memory and are recalled when the system is turned back on.

Every model has its own trim setup. Also all flight modes may be configured to use different trim configurations. By pressing one of the buttons, the screen will automatically change to display the graphic position of that trim. The transmitter trims feature an acoustic step and center beep alarm.

4.6 Transmitter Battery Pack

The DS-12 transmitter is powered by a Li-Ion type battery pack and comes equipped with its own built-in advanced battery management and charging circuit. In switched-on position, the transmitter LCD display shows the status and condition of the battery pack. The Li-Ion battery is factory installed.

4.6.1 Charging

The DS-12 transmitter can be charged with the included wall power supply, optional car charger, or through the built-in USB port. For fast charging use the included wall power supply. Charging time is around 3 hours. During the charging process the transmitter can be in switched-on or off position. The charging status is clearly shown by lit green LED. If the transmitter is switched on during the charging process you can see the charging progress directly on the LCD display.

Transmitter Charging:

1. Plug-in the included power supply to a wall outlet.
2. Plug the main charging connector into the transmitter. If the green LED goes out, the transmitter is not fully charged. The red LED indicates the battery charging status.
 - Discharged battery – red LED is slow blinking, the green LED is OFF
 - Close to full charge – red LED is permanently ON, the green LED is OFF
 - Fully charged battery – the green LEDs are ON

4.6.2 Battery Replacement

Should you decide to replace the transmitter battery, please follow these steps:

1. Switch off the transmitter and remove the 7 screws that secure the radio back cover. Next, remove the radio back cover.
2. Disconnect the transmitter battery connector.
3. Loosen the battery fastening strap and remove the battery.

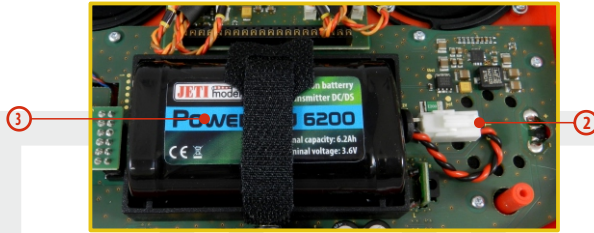

Note: If the transmitter battery has been disconnected for longer than 1 minute, the time and date will be deleted.

Warning: DS-12 transmitters should only be operated with original or manufacturer approved battery packs. The use of other battery packs will void the warranty.

4.7 PPM Input/Output Connector

The **PPM** output is accessible via connector labeled "B". This connector features the non-stabilized battery voltage output in the range of 3.2V - 4.2V (max. 1A) which can be used as power supply for the connected HF module as well as for the PPM signal output. The transmitter output functions are in the form of a standard PPM signal.

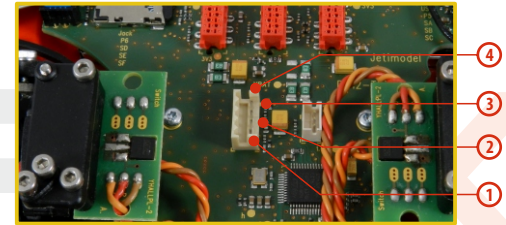

1. PPM input (3V logics)
2. Positive (+) pin
3. Negative (-) pin
4. PPM signal output (3V logics, configurable in „System->Configuration“)

4.8 Handling

The DS-12 is equipped with a handle for practical manipulation as shown in the picture.



The transmitter 2.4GHz antenna locations are shown in the picture below.



Warning: Before each flying session, and especially with a new model, it's important to perform a range check. If you are operating a model with a DS-12 transmitter do not shield and avoid contact of the transmitter antennas (see Photo) with your body.

4.9 Change SD Card

Disconnect the battery plug .

To open the SD card holder, use a fingernail to push the metal frame to the right and then lift it carefully . The micro SD card can now be removed . For installation, proceed in the reverse order .

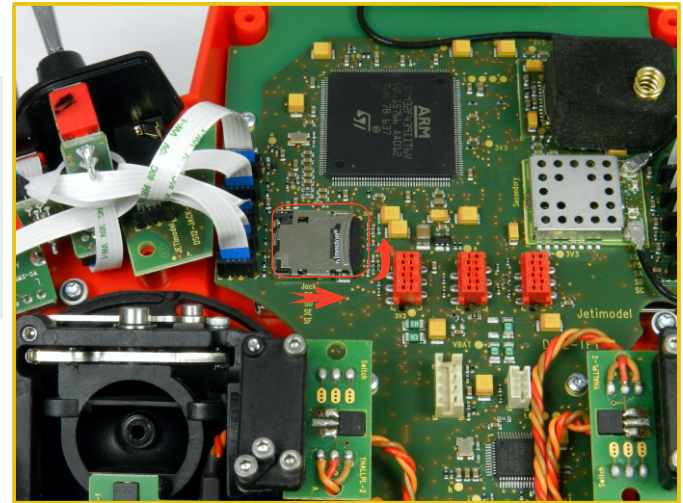

5 RF Transmitter Modules

In order to achieve the highest transmission quality and reliability of the DS-12 transmitters, we have decided to equip the radio with two independent transmitter modules (DUPLEX 2.4GHz and 900MHz NG). The transmitter modules have separate antennas. From the point of transmission they are fully independent from each other. The RF modules of the transmitter can operate in following modes:

- **"Default" mode** – the 2.4GHz Duplex module communicates with the receiver using its two independent antennas. This improves safety and helps to cover dead angles as well.
- **"Double Path" mode** – the transmitter RF module communicate independently with two different receivers. The receivers can be interconnected via an intelligent synthesizer, for instance the JETI Enlink, or the basic control functions can be divided between two independent receivers. In this mode the 2.4GHz Duplex module communicates independently with two receivers. This greatly improves safety and reliability since both receivers communicate independently with the RF module.
- **„Student" mode** – the 2.4GHz Duplex module is assigned to communicate with the instructor transmitter only. Communication with the model takes place via instructor's transmitter only. If you operate two of the DS-12 transmitters, one of them in the "Instructor" mode and the other one in the "Student" mode, the transmitters communicate between each other via cable connection.

- **Back-up Transmitter Module**

The DS-12 are equipped with a wireless backup system . This works on the 868MHz (EU) or 915MHz (US, AU, JP) band . This backup system can optionally be used to the "standard" and "2-way RF" modes. So it is not designed as a single transmission path and provides additional redundancy in addition to the 2.4GHz system .



Recommended connection for Rsat900 NG as a backup receiver with a Central Box

- Always connect the Rsat2 or R3/R5W as the primary receiver in the "RX1" slot of the Central Box.
- The Rsat900 NG is connected to the "Rx2" slot of the Central Box
- Both receivers are set to EX Bus output.

Connecting the RSat 900 NG directly to a Primary receiver:

- The Rsat900 receiver is plugged into the "Sat1" slot of the primary receiver.
- The Rsat900 NG receiver is set to PPM output and the primary receivers "Sat1" slot is set to PPM input.

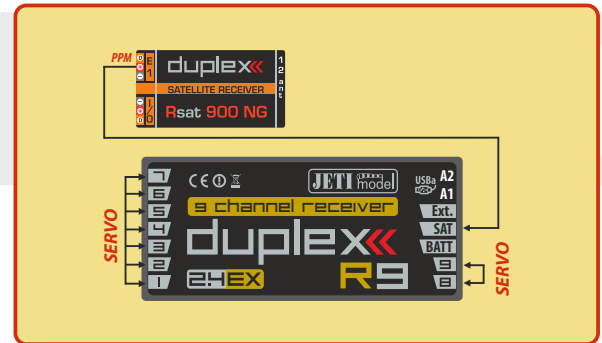
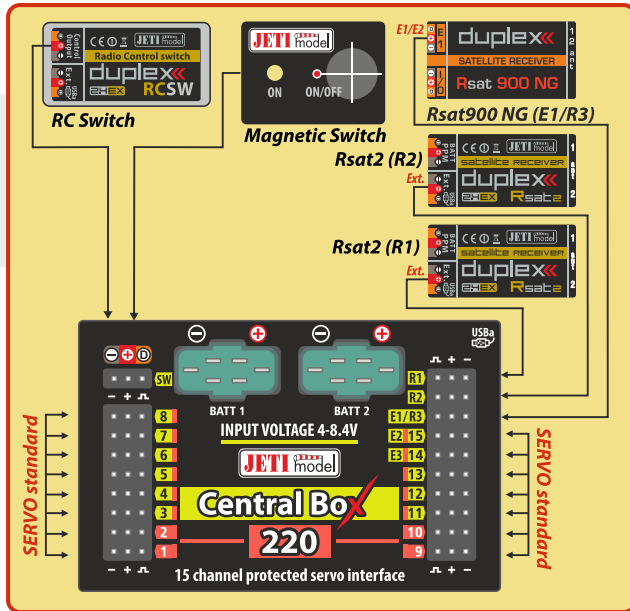

6 Transmitter Powering ON/OFF

6.1 Transmitter Powering-ON

Switching-on is achieved by pressing and holding the **"Power"** button (1). The green LED turns ON and the initial screen appears on the LCD display. At this point transmitter is waiting for final confirmation – press the **F5 (Yes)** button (2). After confirmation, the main screen is displayed and the transmitter is ready. The power-on status of the DS-12 transmitter is indicated by the lit green LED.



* If you do not confirm powering-on within a certain time limit, the transmitter will turn off automatically. In the DS-12 transmitter setup you may disable the confirmation by changing in the setup menu **"Main menu->System->Configuration->Fast switch-on"**.

Advice: We recommend that you leave the transmitter with the switch-on confirmation enabled, as this function prevents accidental turning-on and discharging of the transmitter battery.

6.2 Transmitter Turning-OFF

The transmitter is switched-off by pressing the **"Power"** main button. Before complete power-down is achieved you will be asked for additional confirmation. In case of an emergency, a fast turn-off can be achieved by simultaneously pressing and holding the **"Power"** and **"esc"** buttons. **NEVER** use this alternative during normal working conditions.

Advice: If you want to find out the battery status on a switched-off transmitter just push the button "Power" and the initial screen with the battery status will appear. If you do not confirm turning-on, the transmitter will shut down automatically. During the charging process this function is always activated.

6.3 Transmitter Restart

In case of erratic behavior we recommend that you restart the DS-12 to reboot the operation system.

1. Standard switch-OFF and ON with main „Power“ button.
2. If necessary, use the Emergency Switch-OFF by simultaneously pressing and holding the „Power“ and „esc“ buttons.
3. Disconnect and reconnect the transmitter battery connector.

[a) Remove the screws that secure the radio back cover. Next, remove the radio back cover, b) Disconnect the transmitter battery connector, c) Press the "Power" button to discharge the internal capacitors, d) Reconnect the transmitter battery, e) Reconnect transmitter battery pack and reinstall radio back cover and cover screws, f) Restart the system.]

7 Initial switching-on

Turn the transmitter on by pressing and holding the „Power“ button for a couple of seconds and then press the "F5 (Yes)" button to confirm, see chapter 6.1. The display shows the Main screen and displays the currently loaded model aircraft.

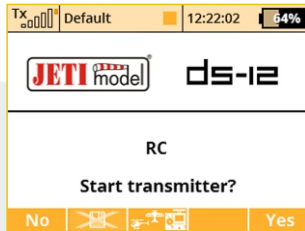

You can also immediately select a different model after the transmitter starts by pressing the "F3" button.

By pressing the "F2" button you are able to disable the logging feature for a current session. If you are just making adjustments to the model configuration, press the "F2" button and confirm. The logging will be disabled until restart of the transmitter.

To make the start-up screen visible, in the Configuration Menu, you have to select "No" for the "Disable startup question" option.

7.1 Main display

The main screen displays basic information about operation of your transmitter, such as the battery level, time, flight mode, etc. This screen will also display the user defined information you want to monitor, for example: **stopwatch, telemetry values, etc.** The main screen consists of three main sections: **the status bar, the desktop and the lower bar.**

The status bar at the top of the main display displays the following information:

1. Signal strength
2. Battery status
3. Time
4. Telemetry recording icon
5. Model Name
6. Name of actual flight mode
7. Throttle Lock
8. Motor cut-off indication, idle

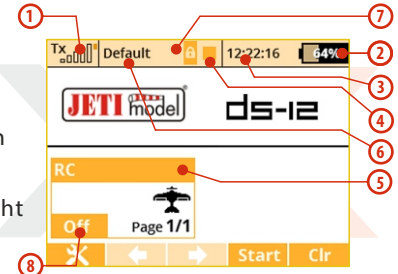

The Desktop is the largest part of the screen. This is where you can see your telemetry data and where any programmed alarms are displayed. The Desktop displays your user-defined information through the use of multiple pages. As you add or remove telemetry items or alarms, the number of available pages will automatically increase or decrease as needed.

The lower bar is found at the bottom of the main display.

The lower bar shows:

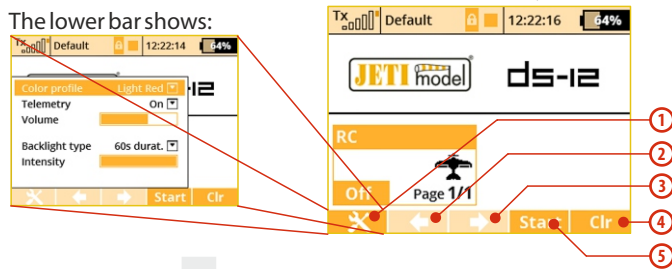

1. **Tools** - fast transmitter setup: **Color profile, Telemetry, Volume, Backlight duration, brightness**
2. **Left Arrow**-move left within the desktop pages.
3. **Right Arrow**-move right within the desktop pages.
4. **Clr**-resets the timers or opens the Data Analyzer application in the main desktop window.
5. **Stop/Start**-begin and end flight timer, triggering timers or telemetry recording.

Use the corresponding **F1-F5** buttons to select these options

From the main display you may access the main menu by pressing the "menu" button. To return from the main menu press either the "menu" or "esc" button.

From the main display, when you push any of the trim buttons or the **3D button** the "Trim menu" will be displayed.

7.2 Navigation in the Menu

7.2.1 Navigation

1. The „menu“ button allows you to switch between the main display and the transmitter's main menu.

Advice: Also, if you push this button while turning the 3D Control Selector to edit values, the values can be changed faster. With the menu button pressed, 10 more values are changed per turn.

2. The "esc" button allows you to move one level back within the menu. If you push this button while you are editing a value you will return one menu level and the edited value will NOT be stored.
3. **3D Control Selector**
 - 3a - by turning the selector **counter-clockwise you will move up in the menu**. Turning the selector this direction will also **decrease** any value you are editing.
 - 3b - by turning the selector **clockwise you will move down in the menu**. Turning the selector this direction will also **increase** any value you are editing.
 - 3c - by **pressing** the selector you will confirm your choice/enter the selected menu.
4. The „F1 - F5“ functions buttons located below the display are used to select various options based upon the current display.

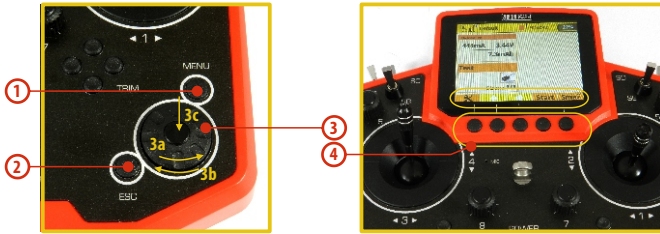

7.2.2 Browsing through the Menu

The current selection within the menu (cursor) is designated by reversed text/shaded graphics. By turning the 3D control selector left/right you will move through the lines of a menu.

To select an item, first highlight the line and then press the **"3D button"**, to select the line. Rotate the 3D control selector to highlight your selected item within the line, then press the **"3D button"** to select the item. Rotate the 3D control selector either left or right to change the value of your chosen item. By pressing the **"3D button"** again you will confirm the storage of your selected value and go back to your previously selected menu item. If you want to go back to select another line within the previous menu press the **"esc"** button.

Note: For each press of the "esc" button, you are taken back one menu level.

7.2.3 Basic Menu Structure

* Model

- Select Model
- New Model
- Basic Properties
- Model Image & Colors
- Functions Assignment
- Servo Assignment
- Servo Setup
- Device Explorer

* Fine Tuning

- Flight Modes
- Digital Trim
- Flight Mode Trim
- Dual Rate/Expo
- Function Curves
- Aileron Differential
- Gyro Settings (Heli)
- Throttle Limiter (Heli)
 - V-Tail, Delta Mix, Ailevator Mix (Aero)

- Butterfly (Aero)
- Snap Roll
- Free Mixes

* Advanced Properties

- Other Model Options
- Sticks/Switches Setup
- Wireless Modes/Trainer
- Logical Switches
- Sound on Event
- Sound of Prop. Controls

- Telemetry Controls
- Voice Commands
- Sequencer
- Accelerometer

* Timers/Sensors

- Timers
- Alarms
- Vario
- Voice Output
- Sensors/Logging Setup
- Displayed Telemetry
- Main Screen

* Applications

- Data Analyzer
- Audio Player
- JETIBOX
- Games (Snake, Tetris, Chess...)
- Image Slideshow
- Microphone
- User Applications

* System

- Configuration
- Servo & Range Test
- View Inputs
- Receiver Output
- System Sound
- Sound Volume
- USB
- Info

7.3 Model Set-up Guide

In this section we will guide you, step by step, through the process of creating a new model airplane and helicopter. Each step of the guide will be complete with associated transmitter menu photos. If you follow the step by step guide you should become familiar with how to create a model profile. You may even use these concepts and the "General" model type to create your own, user-defined model profile.

7.3.1 Airplane

Let's create a simple model airplane. Our example will be a motor glider with ailerons controlled by two servos, an elevator and a rudder each controlled by one servo.

Servo assignment:

1. Throttle
2. Aileron 1
3. Aileron 2
4. Elevator
5. Rudder

Before you begin creating a model, make sure that you have set up the correct transmitter mode in "Main menu -> System -> Configuration -> MODE 1-4". The basic, standardized, assignment

of transmitter inputs to flight controls are based upon this selection.

First it is necessary to create a model in the transmitter and then bind the DS-12 transmitter with the receiver which will control the given model. **See chapter 8.3: „Receiver->Binding“.**

Warning: For safety reasons we recommend first removing the propeller.



1. Switch-on the transmitter. In the main display push the key „menu“. Select the item „Model“ and push the „3D button“.

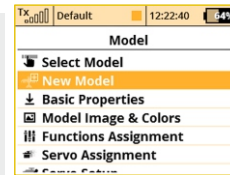

2. Select the item „New model“ and push the „3D button“.

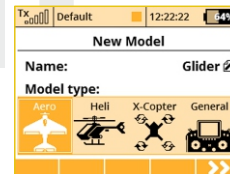

3. Enter the name of your model and press „F5(OK)“ (Note: you must enter a model name to proceed.) Then select the model type „AERO“. Confirm by pushing the „F5(Next)“ button.



4. Choose an optional model image and color profile according to your personal preferences. The images must be loaded to the internal SD card before you use them. You can skip this step by pressing "F5 (Next)" button.

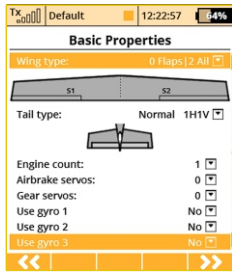

5. Select your wing type. Because this example has 2 aileron servo, select „**Wing type**“ **OFLP/2WING**. Do not change any other setup items like tail assembly, number of motors, number of spoilers or number of landing gear servos. Continue by pushing the „**F5(Next)**“ button.

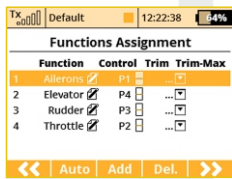

6. This page displays the flight control functions and their transmitter switch assignments. Here you can verify that your flight control functions are correctly assigned to the transmitter switches/sticks. If they are not, check and make sure that you have selected the proper transmitter mode. Confirm the assignments by pushing the "**F5(Next)**" button.



7. This page displays the assignment of functions to your receiver outputs (servos). You may change the assignments by editing the output assignment for each receiver channel. Otherways confirm with the "**F5(Next)**" button.



8. The screen will now display a request which asks if you really want to create and activate the new model. Confirm with the "**F5(Yes)**" button.

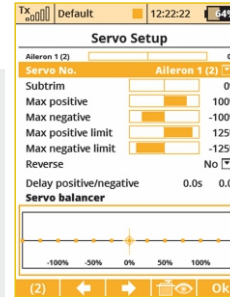

9. The Servo Setup menu is where you set the servo neutral positions, servo output travel limits, servo reversing, delay etc. You will come back to this menu after binding the receiver with your transmitter. Press the "**F5(OK)**" button and you are taken to the main screen where your new model is displayed in a desktop page.

Bind transmitter with the receiver, **see chapter 8.4 Receiver->Binding**.

Once your transmitter has been bound with the receiver and you have re-applied power to the receiver, the last setup phase is the tuning of your servo output functions, **see chapter 7.3.5 Setup of receiver outputs**.

With this type of wing configuration there is usually a mixer used to also raise the ailerons as spoilers (spoilerons). Follow the steps below the set up this mixer. In this example we will use the "**right side control lever(5)**" for the proportional control of the spoilerons.

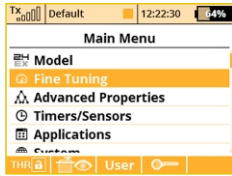

a. From the main screen, push the „menu“ button. Select „**Fine tuning**“ and push the „3D button“.

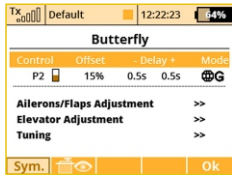

b. Next, select „**Butterfly**“ and push the „3D button“.

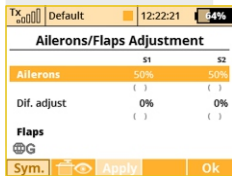

c. In the first menu line push the "3D button", select 'Switch' and push the "3D button" again. Next, move the "right side control lever(5)". Confirm with the "F5(OK)" button. The last step in this menu is to set the amount of travel that your ailerons will move as spoilerons (or flaperons) and to set any desired elevator compensation.

Note: When setting up your spoilerons be sure that the ailerons still have enough travel to control your airplane when the spoilerons are deployed. In this menu the "(Sym) F1" button will link or unlink the spoilerons if you need to set them independently

7.3.2 Helicopter

Let's create a simple model helicopter. In this example, the helicopter is controlled by a swash plate with three servos at 120° orientation and the motor has no governor.

Servo assignment for the receiver channels:

1. Throttle
2. Elevator (Swash 1F)
3. Collective (Swash 2L)
4. Aileron (Swash 3R)
5. Rudder (Yaw)
6. Gyro (Gyro sens.)

Before you begin creating a model, make sure that you have setup the correct transmitter mode in "Main menu -> System -> Configuration -> MODE 1-4". The basic, standardized, assignment of transmitter inputs to flight controls are based upon this selection.

First it is necessary to create a model in the transmitter and then bind the DS-12 transmitter with the receiver which will control the given model. **See chapter 8.3: „Receiver->Binding“.**

Note: For safety reasons we strongly recommend removing the main/tail blades or disconnecting the motor when working with an electric helicopter.



1. Switch on the transmitter. In the main display push the key "menu". Select the item "Model" and push the "3D button".

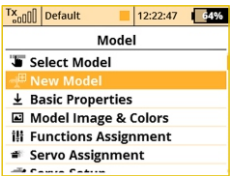

2. Select the item „New model“ and push the „3D button“.

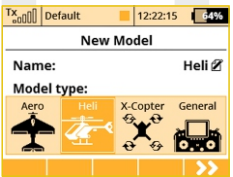

3. Enter the name of your model and press "F5(OK)" (Note: you must enter a model name to proceed.) Then select the model type "Heli". Confirm by pushing the "F5(Next)" button.

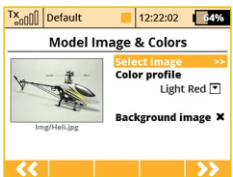

4. Choose an optional model image and color profile according to your personal preferences. The images must be loaded to the internal SD card before you use them. You can skip this step by pressing "F5 (Next)" button.

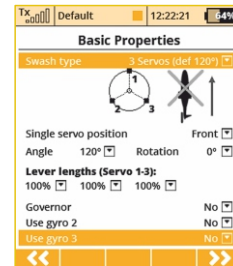

5. Select the helicopter swash plate type "3 servos (def 120°)". Change the second menu item "Position of front servo" to "Rear" – the swash plate servo orientation will be turned 180°. Confirm the change by pressing the "F5(Next)" button.

When you create a new helicopter model, you are required to define the swash plate configuration for the model.

Please refer to your helicopter's instructions and verify that you have the correct swash plate configuration. If you find that you need to change your swash plate configuration, you can always go to the "Model->Basic Properties" menu to make the change.



6. The "Functions Assignment" menu lists the flight functions and their control switch/stick assignments. If you want to change any of the switch/stick assignments, select the "Control" item for your flight function and then select your desired switch/stick for that flight function. Press "F5(Next)" to confirm.



7. The „Servo assignment“ menu displays the receiver channels and their transmitter output assignments. If you want to change any of the output assignments, select the channel you want to edit and reassign its output. Otherways press „F5(Next)“ to confirm.

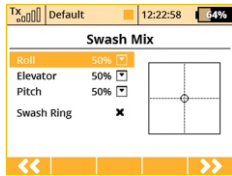

8. The "Swash Mix" menu displays the travel range of each particular helicopter flight function for the swash plate for flybarred helicopters. The travel range is displayed as a percentage. You can use these travel range adjustments to prevent linkage binding and to tune the helicopter to suit your flying style. You can also activate a cyclic reduction of the rotor head travels (Swash Ring) so the servos cannot be damaged by large simultaneous movements of the sticks. (Refer to your helicopter's instruction manual.) Press the "F5(Next)" button to confirm.

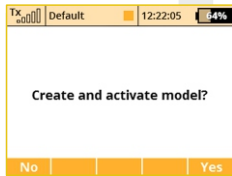

9. The screen will display a question which asks if you really want to create and activate the new model. Press the "F5(Yes)" button to confirm.



10. The "Servo Setup" menu is where you can set all of your servo neutral positions, servo output throw limits, servo reversing, delay etc. You should return to this menu after you have bound your receiver and transmitter. **See chapter 8.3: Receiver->Binding.**

11. Once your transmitter has been bound with a receiver and has been connected to its power supply, the last step consists of tuning the servo output functions, **see chapter 7.3.5: Setup of receiver outputs.**

In the "Fine tuning -> Flight modes" menu you will setup these advanced model control functions for your helicopter:

Collective pitch curve, see: **Fine tuning -> Flight Modes->Function Curves**

Throttle curve, see: **Fine tuning -> Flight Modes->Function Curves**

Dual rates, see: **Fine tuning -> Dual Rate/Expo**

Autorotation, see: **Fine tuning -> Flight Modes**

Gyro/Governor see: **Fine tuning -> Gyro/Governor**

For convenience, a quick link to all of these function settings has been made through the Heli Tuning menu.

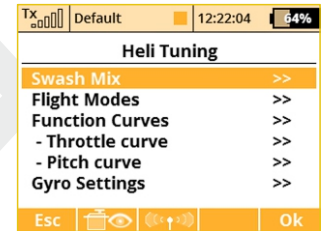
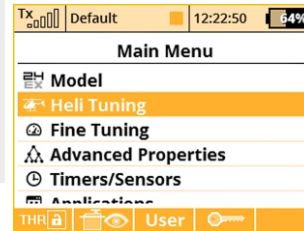

7.3.3 Multicopter

The DS-12 transmitters allow you to simply create a multicopter model equipped with gear and camera gimbal. By default, after the creation of a multicopter model, the digital trims are disabled.

Servo assignment to receiver channels:

1. Throttle
2. Roll (ailerons)
3. Pitch (elevator)
4. Yaw (rudder)
5. Mode (multicopter mode channel)

Before you begin creating a model, make sure that you have setup the correct transmitter mode in „Main menu -> System -> Configuration -> MODE 1-4“. The basic, standardized, assignment of transmitter inputs to flight controls are based upon this selection.

First it is necessary to create a model in the transmitter and then bind the DS-12 transmitter with the receiver which will control the given model. *See chapter 8.3: „Receiver->Binding“*

Note: For safety reasons we strongly recommend removing the propellers when working with a multicopter model.



1. Switch-on the transmitter. In the main display push the key „menu“. Select the item „Model“ and push the „3D button“.

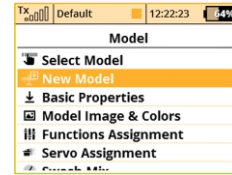

2. Select the item „New model“ and push the „3D button“.

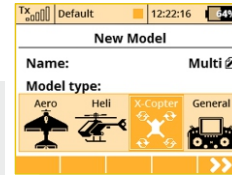

3. Enter the name of your model and press „F5(OK)“ (Note: you must enter a model name to proceed.) Then select the model type „X-Copter“. Confirm by pushing the „F5(Next)“ button.



4. Choose an optional model image and color profile according to your personal preferences. The images must be loaded to the internal SD card before you use them. You can skip this step by pressing „F5 (Next)“ button.

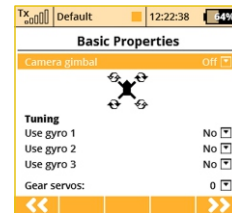

5. Select the basic properties of your multicopter, i.e. type of camera gimbal (off, two axes or three axes), number of gyro tuning functions and gear servos.

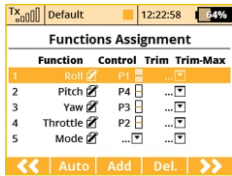

6. This page displays the flight control functions and their transmitter switch assignments. Here you can verify that your flight control functions are correctly assigned to the transmitter switches/sticks. If they are not, check and make sure that you have selected the proper transmitter mode. Confirm the assignments by pushing the „F5(Next)“ button.



7. This page displays the assignment of functions to your receiver outputs (servos). You may change the assignments by editing the output assignment for each receiver channel. Otherways confirm with the „F5(Next)“ button.



8. The screen will now display a request which asks if you really want to create and activate the new model. Confirm with the „F5(Yes)“ button.



9. The Servo Setup menu is where you set the servo neutral positions, servo output travel limits, servo reversing, delay etc. You will come back to this menu after binding the receiver with your transmitter. Press the „F5(OK)“ button and you are taken to the main screen where your new model is displayed in a desktop page.

10. Bind transmitter with the receiver, **see chapter 8.3 Receiver->Binding**. Once your transmitter has been bound with the receiver and you have re-applied power to the receiver, the last setup phase is the tuning of your flight controller channels, **see chapter 7.3.5 Setup of receiver outputs**. Set the correct subtrims and endpoints, so that the flight controller unit recognizes the channels as valid.

7.3.4 General

The DS-12 transmitters are not only equipped with the assistants for airplanes or helicopters, but they also have a „General“ assistant which can be used to create just about any other type of model. If your model cannot be assigned to the category of an airplane or helicopter, select the general model. The following setup describes the creation of a boat model. This process could also be used to create a profile for any other land/water/air model craft. In this example, the model is controlled by basic functions like throttle and rudder as well as by extended functions like a motor sound generator, lighting system, siren, and a smoke generator. The first three above mentioned functions are controlled proportionally and the rest are non proportional.

Servo assignment to receiver channels:

1. Motor
2. Rudder
3. Motor Sound Module
4. Lighting System
5. Siren Sound Module
6. Smoke Module

Before creating a model, make sure that you have setup the correct transmitter mode in "Main menu -> System -> Configuration -> **MODE 1-4**". The basic, standardized, assignment of transmitter inputs to flight controls are based upon this selection. First it is necessary to create a model in the transmitter and then bind the DS-12 transmitter with the receiver which will control the given model, see chapter 8.3: "Receiver->Binding".

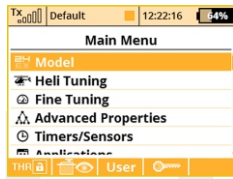

1. Switch-on the transmitter. In the main display push the key „menu“. Select the item „Model“ and push the „3D button“.

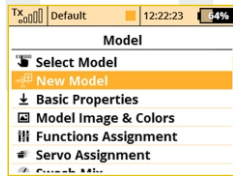

2. Select the item „New model“ and push the „3D button“.

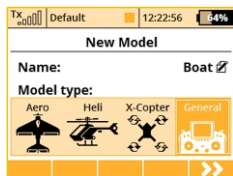

3. Enter the name of your model and press „F5(OK)“ (Note: you must enter a model name to proceed.) Then select the model type „General“. Confirm by pushing the „F5(Next)“ button.

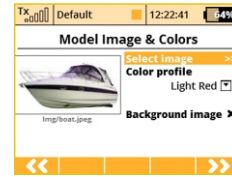

4. Choose an optional model image and color profile according to your personal preferences. The images must be loaded to the internal SD card before you use them. You can skip this step by pressing "F5 (Next)" button.

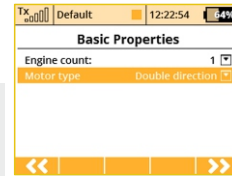

5. The first item in the "Basic Properties" menu is the number of motors in the model. In this example, this item will not be edited and we will proceed to the second item, which is how the motor needs to be controlled – i.e. whether the motor turns only one direction (Single) or both directions (Double). Edit the item "Motor type" by selecting "Double direction". Press the "F5(Next)" button to confirm.

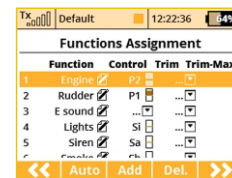

6. In the "Function Assignment" menu use the "F3(Add)" button to create all of your desired functions. Then you can assign transmitter control switches/sticks to the functions by editing each function's "Control" item, see chapter: "Select control input". The only exception is the motor sound module function, which you cannot simply assign to a control switch/stick, because it will be controlled by a mixer. The mixer will allow the motor sound will be played proportionally to the motor speed. For the siren function you may take advantage of the switch "Sa"

(spring-loaded switch). After you create all of your desired functions, press the „F5(Next)“ button to confirm.



7. The "Servo assignment" menu displays the receiver channels and their transmitter output assignments. The channels are assigned in the order that you created the functions in the previous menu. If you want to change any of the output assignments, select the channel you want to edit and reassign its output. Otherways press "F5(Next)" to confirm.

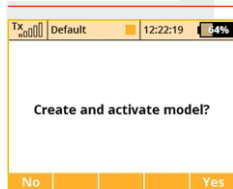

8. The screen will display a question which asks if you really want to create and activate the new model. Press the „F5(Yes)“ button to confirm.



9. The "Servo Setup" menu is where you can set all of your servo neutral positions, servo output throw limits, servo reversing, delay etc. You should return to this menu after you have bound your receiver and transmitter. **See the chapter 8.3: Receiver->Binding.**

Once your transmitter has been bound with a receiver and has been connected to its power supply, the last step consists of tuning the servo output functions, **see chapter 7.3.5: Setup of receiver outputs.**

To complete this model we just need to configure a free mixer from the throttle function to the motor sound module. In this example we will set a switch to enable/disable the mixer so that when the switch is "on", the motor sound module is controlled with the throttle (motor speed). Go to the "Fine tuning->Free mixers" menu.



a. Use the „F2(Add)“ button to create a new mixer. Select „Engine“ in the „From“ item. Then select „Sound M“ (the name of the sound function) in the „To“ item. The item „Master Value“ represents the amount of mixing from the input function

to the output function for this mixer. With the „F5(Next)“ button you will create the mixer and the display will change to show the overview of your programmed free mixers.

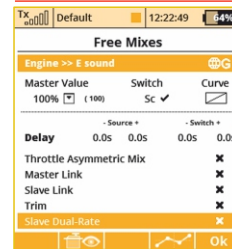

b. To assign a switch for the activation and deactivation of the free mixer, press the "F4(Edit)" button. Select and edit the "Switch" item to assign a switch/stick to enable/disable the mixer.

7.3.5 setup of Receiver Outputs

Go to the **"Model->Servo Setup"** menu. Use the **"F2"** and **"F3"** buttons to brows through the receiver outputs (channels).

You can scrol through the following servo adjustment items for each channel:

„Servo reversing“ – reverses the servo throw direction.

Move the stick for your selected channel and observe the direction of the servo movement. If the servo moves in the opposite of your desired direction, change the direction by editing the „Reverse“ item for that particular servo. Continue with each channel until all of theservos travel in the required directions.

„Center (Subtrim)“- adjusts the center position of each servo's output.

With your sticks in their neutral positions, scroll through each servo's page and use the "Center (Subtrim)" item to correctly set all of your servo's center or neutral positions.

Note: *You should mechanically adjust all of your servo arms and servo linkages to be as close to neutral or center as possible so that you will need as little subtrim as possible. Using large amounts of subtrim can limit the overall throw of your servo.*

„Max/Min. limit“ – sets the absolute maximum servo output throw

Use these to limit the maximum range of servo throw in order to keep your servos from exceeding their mechanical limits or to keep your servos from binding when moving their arms or linkages to

their full travel. You should use the dual rate function to set your model's useable control throws.

8 Receiver

8.1 Description



1. JETI Duplex receivers use the universal or „JR Type“ servo connectors.
2. **Bat** - receiver and servo power supply input. Whenever possible, always supply power to your receiver using more than one of these inputs. You can either supply power through the use of a Ycable or through any unused receiver channel connection. To power the receiver you may use NiCd packs, the BEC from your ESC or Li-xx cells used with a voltage regulator, such as the JETI MAXBEC or similar.
3. **SAT** - auxillary input/output for PPM signals. This input allows you to connect an additional JETI DUPLEX Rsat2 satellite receiver or an additional US version Duplex receiver. This allows you to increase the number of receiver antennas in your system for increased reliability in installations with shielded or badly oriented antennas.
4. **EXT** - input for telemetry sensors. If you want to connect more than one telemetry sensor then use the JETI EXPANDER E4. You can „daisy-chain“ several of the E4 Expanders to support many, many sensors.

5. **A1/A2** - receiver antennas. The antennas should be installed so that the wires form a 90° angle relative to each other.

8.2 Installation

Whenever possible, you should wrap the receiver in foam and place it as far as possible from sources of interference (servos, electric motors). Arrange the receiver antennas so that their active ends form a 90° angle and try to put them as far as possible away from each other. Take care not to bend them with a radius smaller than 1 cm. The active part of the antenna should not be placed close to metal parts. If your model has a carbon fuselage it is very important to place the active antenna ends outside the fuselage.

8.3 Binding

In order to achieve communication between transmitter and receiver you must bind them. During this process the transmitter learns the receiver address and will automatically find it again when switched back on. Communication begins with this receiver automatically if the transmitter is not already communicating with another receiver. The binding process needs only to be done once for each receiver.

8.3.1 Standard pairing procedure

1. Switch off the transmitter and receiver.
2. Plug the „**BIND PLUG**“ into the **EXT** receiver input.
3. Connect receiver power supply.
4. Switch on the transmitter. The receiver will bind with the primary transmitter module.

8.3.2 Alternative pairing procedure through the transmitter menu

1. Turn off the receiver. Keep the transmitter turned on.
2. Plug the **"BIND PLUG"** into the EXT receiver input.
3. Connect receiver power supply.
4. Locate the transmitter menu **„Advanced Properties -> Wireless Modes/Trainer“**
5. Highlight **"Pair primary TX module"** and press the **„3D button“**.
6. The receiver will bind with the transmitter. Confirm the registered device.



8.4 Range Test

The range test will verify that the transmitter and receiver are functioning properly.

Before the first flight of each flying session or if have any doubts about the transmitter or receiver function, you should always check the range. During the range test the transmitter's output power is decreased to 10%.

When performing a range test, both the model and the transmitter should be at a minimum height of 80 cm (31.5") above the ground. A correctly functioning transmitter and receiver in range test mode should safely control a model to a minimum distance of 50m (164'). If not, check your model's antenna installation first. If the test is still not successful, don't fly the equipment and contact your retail shop or one of the JETI authorized service centers.

8.5 Fail safe

All Duplex 2.4GHz system receivers are equipped with **"fail safe"**, a function which reacts to control signal transmission interruptions. When your receiver for any reason does not receive transmitter information, it changes, after a pre-set time period, to one of the following modes.

„Repeat“ – This mode holds the last valid control throw signal (this is the default mode for all receivers)

„Out off“ – There is no output signal provided by the receiver, i. e. servos do not keep their positions

„Failsafe“ – receiver outputs change to preset positions

Each receiver channel can be configured to one of the modes described above. We recommend that you setup "fail safe" positions for every output, which enables your model to stay in a stable condition. For instance, the elevator and rudder in neutral positions, electric motor switched-off, gas engine idling, spoilers extended.

Configuration Method of the receiver failsafe function.

1. Bind receiver with transmitter. **See chapter: 8.3 Binding.** Leave receiver and transmitter in switched-on condition.
2. In the transmitter, go to the menu „**Applications -> Jetibox**“ and proceed according to picture. Use the **F1-F4** function buttons to move within the menu.
3. In the „**Set Output Pin**“ menu select the receiver output which you want to configure (use the left/right buttons) and proceed (by using the down-button).
4. In the "**Signal Fault Yn**" menu where n denotes the channel number which has to be configured, use the right-button to edit the output function showing a signal failure (setup "fail safe"). You have now activated the "**fail safe**" function on receiver channel output n.
5. The "**fail safe**" is adjusted by pressing the down-button and changing to the „**fail safe**“ menu. With the left/right buttons edit the "fail safe" value in a range of 0.8ms to 2.2 ms. Adjust all of the connected receiver outputs by repeating steps **3-5**.

The last parameter to be set up is the elapsed time after signal failure when the "**fail safe**" or other actions after signal failure will be initiated. In the "**SignalFault Delay**" menu you can define the length of time after a signal fault occurs in which the preset throws are applied. The values in this menu are changed by pressing the left/right buttons.



8.6 Using Device Explorer To Configure the Receiver



The Device Explorer utilizes the latest data/command **EX Bus** protocol to wirelessly configure remote devices such as receivers, sensors and other **EX Bus** compatible devices. You can check the label of your device to see if it supports the **EX Bus** protocol.

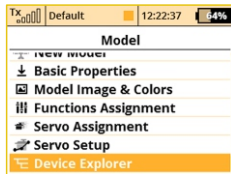

Basically, the Device Explorer (located in the Model menu) replaces the integrated JETIBOX emulation and brings additional, more intelligent ways to communicate with your remote devices. The main Device Explorer window shows a list of available devices. The recognized devices are labeled with their registered name, others are not displayed or only displayed as a device ID. The check mark tells you that the device is ready and that you can configure it. By using the **"F3" Refresh** button you can reset the displayed devices, this forces the auto-detection function to explore all attached devices. The remote sensor and device detection process is always running in the background.

In the picture above, two receivers have been detected and are recognized. When you press the rotary button, you are able to configure them in detail. Here is the example how to use the Device Explorer to configure an **"R9 EX"** receiver:

First, the transmitter downloads all settings from the receiver. After that operation is completed you should be able to see the basic configuration of the receiver as shown in the picture **a)**. Every modification that you make is automatically uploaded back to the receiver, so that you can immediately see results of the steps you are



doing and there is no need to continuously **"save"** your changes. For your convenience, there is a **"Refresh"** button **"F3"**, which causes all of the data to be downloaded from the receiver once again. This is beneficial mainly if you are modifying the configuration by using a JETIBOX device and the Device Explorer simultaneously.

The **"F2"** Tools button is used to enter a special dialog where you can import and export settings of the particular device. If you want to export the configuration of your (for example) receiver, just enter the **"Export settings"** menu item, set the file name and confirm. Similarly you can import this configuration to the device. All the exported files are stored in the **"Export"** folder on the SD card.

Note: Before a device can be recognized, a special predefined configuration scheme must be present on the SD card in the /Devices folder. If the scheme doesn't match or doesn't exist, an error message "Unknown device" is displayed. If such an error occurs, please download the latest software for your DS-12 which, by default, has all the definitions included, or contact your dealer for assistance. This text describes properties introduced in receiver version 3.20.

The picture a) shows the following adjustable parameters:

- **Serial Link** – This determines the operational mode of the receiver. You can choose from these options:
 - **JETIBOX & Servo** – The standard mode for direct servo control.
 - **PPM Positive, PPM negative** – the servo signal is summed into a standard or inversed PPM signal. This option is for devices which can use single line servo output data. Direct connection of servos in this mode is supported as well.
 - **EX Bus** – Tells the receiver that it should send all data onto a fast digital serial link for further processing. This is the recommended option if you are connecting the receiver to the Central Box or another **EX Bus** intelligent device.
 - **UDI - Universal Data Interface.** - This is a unidirectional digital serial protocol that can transmit up to 12 channels on a single wire. The UDI is compatible with several stabilization systems for helicopters and airplanes.
- **General Settings** - redirects you to screen **b)**
- **Fail-Safe** - redirects you to screen **c)**
- **Alternative Pin Config** - redirects you to screen **d)**
- **Receiver Outputs** - redirects you to screen **e)**

- **Reset to factory defaults...** – After confirmation, the receiver's configuration will be restored to its factory settings.

The next page (General Settings) shows basic properties of the receiver (picture b).

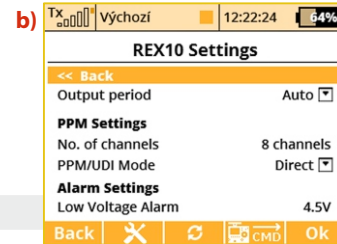

- **Output Period** – Determines how often the servo signal will be repeated to the outputs of the receiver. You can select periods from 5ms to 30ms (in 5ms steps). Recommended option: „Auto“.

PPM Settings

- **Number of channels** – if the output mode selected is either positive or negative PPM, you can set how many channels will show on the output.
- **SAT1/SAT2** - Some types of receivers support input of backup PPM signal. This signal can be captured via SAT1 or SAT2 ports. Here you can define the mode of operation for the particular ports. The PPM input can be accepted only in standard servo mode and EX Bus mode. Additionally, the SAT2 port can be configured as a PPM output. In this case the SAT2 outputs all 16 channels if not specified otherwise.

- **PPM/UDI Mode** - determines processing and additional logic applied to the PPM and UDI protocols.
- **Direct** - signals received from the transmitter are not further on processed in the receiver, they are generated without any change at the output of the receiver in form of PPM/digital signals. If a signal loss occurs, no PPM/digital data will be generated by the receiver.
- **Computed** - the signals received from the transmitter can be processed further on in the receiver and its menus "Channel set" and "Out Pin Set" programmable channel outputs, gains etc.)

Alarm Settings

- **Low Voltage Alarm** - the value serves for the setup of the alert decision threshold. As soon as during operation the actual voltage decreases below the set threshold, the receiver will generate an alarm. The transmitter may announce this situation by an acoustic tone (this depends on transmitter alarm settings, please refer to chapter describing "Timers/Sensors->Alarms").

On the next page (picture c)) shows the fail-safe function parameters.

- **Fail-Safe** – This parameter tells the receiver how to react when a signal loss event occurs. If you set "Enabled" then you will be able to set the behavior of every channel independently. The "Disabled" option says that if no signal is being received from the transmitter, no driving signal for the servos (or PPM) will be present.
- **Fail-Safe Delay** – The number of seconds that must elapse from the

moment of losing signal until the fail-safe is activated. This option is available only if the Individual mode is selected.

- Each output position of the receiver has three adjustable parameters:



- **Mode (Hold, Out OFF or Fail-Safe)** – Dictates, how the specific output behaves if a signal loss occurs. Using the Hold mode, the latest known servo position will be held. Out Off option means that there will be no signal to the particular servo channel. The last option, Fail-Safe, will set the servo to (user) predefined position (set in the "Value" column).
- **Value** – The position of the servo after a signal loss occurs. This is available only when the Fail-Safe mode is selected. For convenience, you can press the "F4 Apply" button while you are editing this column. The selected value will then appear directly on the servo output without the need to turn off the RF modules which would eventually activate the fail-safe and show the set position. The "Apply" function makes it faster to set your fail- safe positions.
- **Slope** – This slows down the speed of servo movement while the output is moving from the normal position to the fail-safe position.

The screen **d)**, "**Alternative Pin Config**", allows you to modify the modes of receiver output pins. The servo outputs can be configured into Digital input and Digital output modes.

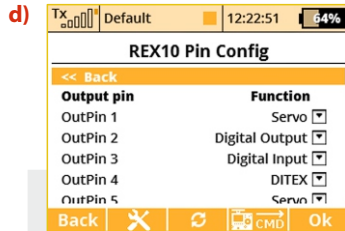

- **Digital input mode:** a logical value of a given signal pin (0 or 1 as a result) is transmitted to the DS-12 in form of EX telemetry so that it can be further on processed (displayed and stored to the SD card). The receiver pins are equipped with internal pull-up resistors. To detect logical value of a given pin it is enough to connect the signal pin with the ground.

- **Digital output mode:** The channel value of a given output pin is discretized into two values. If the channel value is greater than 1.5ms, the pin output will be log.1. Otherwise the signal pin will stay at logical 0. Using this way you can simply control for example lights consisting of several LEDs. The fail-safe configuration is applied in this mode as well as in servo mode.

The page Receiver Outputs (**picture e)**) allows you to redirect your transmitter's channels to any output of the receiver. For convenience the transmitter's channel numbers are displayed together with the appropriate function names, making it easier to adjust. In addition, you can also set the servo group for each channel. For more information please refer to your receiver manual.

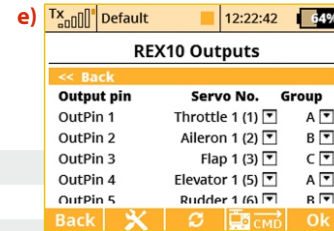

8.6.1 Support of remote commands for EX Bus devices

The DS-12 transmitters support up to 16 universal commands for wirelessly connected devices supporting EX Bus. To view the list of active commands, press the "**F4**" CMD button when in the "**Model -> Device Explorer**" menu. However, the command must be detected before it can be activated. As an example of the use of wireless commands, the Central Box can be used and its command that resets the minimum, maximum values and battery capacity (**Clear MIN / MAX values**).



1. The list of active commands.



2. **Sa** switch is assigned to reset minimums, maximums, and the measured capacity. For the reset command only the Control mode is available (the position of the control/switch is taken as an input), other devices may accept a proportional value specified as a constant or as the channel number on the transmitter.

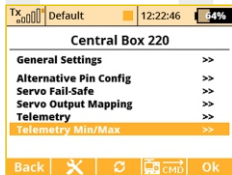

3. Scroll to view minimums and maximums.



4. Pushing the „3D” button enables you to add the command into the list of active commands and it is possible to assign a transmitter control to it.

On the main screen of the Central Box settings scroll down to display the maximum telemetry values (Telemetry Min/Max). Here you will find a choice to assign a switch to the command for deleting measured minimums and maximums (Clear Min/Max switch). Pushing the **"3D" button** on this item you are moved to the list of active commands where this command is already listed and is inversely highlighted with a cursor.

Pushing the **"3D" button** moves you to the choice to assign the control/switch that will further on take care of the command for resetting. Here we have chosen the **Sa** switch.

Further operation of the command will look like this:

- Moving the **Sa** switch into the **ON** position makes the transmitter detect that it should send the command for resetting telemetry minimums and maximums to the model. However, before the command is applied, it is necessary to confirm the choice by the pilot to avoid unwanted resetting of the data.

- The transmitter displays a dialog asking if you want to execute the command for resetting the telemetry. If you press **NO** or you do not manage to respond in time, the dialog closes and the command is not executed.

- Conversely, if you press **YES**, the command is sent to the model where it is processed by the Central Box which resets its telemetry. The result of this command can be displayed on the main screen of the transmitter in the telemetry window – the item Capacity of the Central Box will now be set to zero.

Note: This text describes receiver properties introduced in DS-12 V3.0 and receivers version 3.25. Earlier versions of the firmware might offer different properties, or the described configuration might be entirely inaccessible. Receiver software is updated through a PC with the aid of the JETI USBa adapter. For more details refer to the USBa adapter manual.

8.7 RC-Switch

The RC Switch is a special wireless device that allows you to remotely connect or disconnect the receiver power supply of your model. There are currently two variants of the device: RC Switch and RC Power Switch. The difference is noticeable in the picture below. The simple **RC Switch** is suitable for applications where a **Central Box, Max Bec 2D plus, SBEC 40** or other intelligent electronic device is being used. It offers a single output pin that might be wirelessly driven high or low according to the situation.

When connected in place of a magnetic key, the RC Switch can turn the electronics in the model on and off.

The second variant, the RC Power Switch, can fully replace a standard physical switch. It can directly drive servos and electronics since it includes a couple of low-resistant MOSFETS. Just plug the RC Power Switch between the battery and the receiver, configure the switch-related settings in your transmitter and bind it as a standard receiver.

Variant of the RC Switch

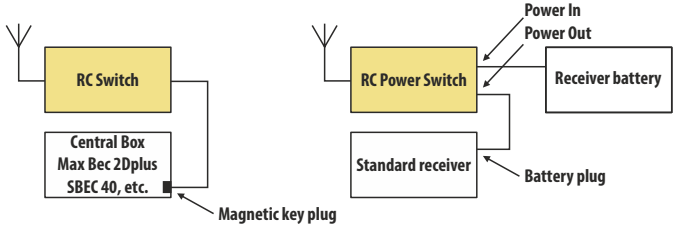

The switch-related settings are located in **Model->Device Explorer->RC-Switch**. First, you have to enable the switch by pushing the rotary button on your transmitter with the first row of the transmitter display highlighted.

Then you should bind the RC Switch:

- Put the bind plug into RC Switch and then turn it on.
- Push the rotary button with the **"Pair RC Switch"** row highlighted on your transmitter display.
- The ID of the switch is automatically saved.

The Transmitter control switch function is a source of events:

If you want to turn the model on, then flip the assigned control switch and confirm the question that appears. If you want to turn the model off, just flip the switch back and also confirm the question.

You can invert polarity of the switch (if high logical level doesn't turn the device on) and also set the audible signals that will be activated every time the status of RC Switch is changed (turned on or off).

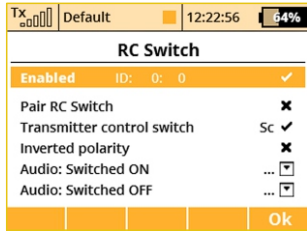

duplexX^{EX}

9 Transmitter to PC Connection

The JETI Duplex line of transmitters are equipped with a mini USB port. The Transmitters also come with a standard USB to mini USB cable which is used to connect your transmitter to a PC. The JETI Duplex system is fully compatible with Microsoft Windows XP and higher versions of Windows OS. After connection and confirmation your transmitter will be identified by the PC as another memory drive. While it is connected to a PC your transmitter's battery is also being charged via the USB port.

9.1 Memory & System Files

After your transmitter has been connected to a PC it will behave like standard external hard drive. Your transmitter's file directory is displayed on the PC screen. Pay close attention to moving, deleting or adding files to any open file directory, any changes performed here have a direct effect on your transmitter's internal data

File Directory

- Apps** – additional user applications written in Lua programming language.
- Audio** – sounds, music, and acoustic warnings
- Config** – software configuration
- Lang** – language configuration
- Log** – telemetry data, all files use date stamp year/month/day
- Manual** – instruction manual
- Model** – programming files of individual models
- Update** – directory used for software updates
- Voice** – audio samples for speech synthesis
- Devices** – device definitions used for communication with intelligent devices based on **EX Bus** protocol

9.2 Update firmware

The JETI Duplex line of transmitters fully support future software updates. We recommend that you check the distributor's and/or manufacturer's web sites frequently for the most current update.

How to update your transmitter's firmware:

1. Connect your transmitter to a PC via USB port
2. Confirm the connection
3. Start Jeti Studio and update your transmitter to the latest FW version. Jeti Studio requires an internet connection to update your transmitter.
4. After the successful data transfer, disconnect your transmitter from the PC USB port and turn OFF the transmitter. The next time that you turn your transmitter ON, the software will be updated.

With any new firmware update no model setups or configuration settings will be lost. For safety, after performing a new update, we highly recommend that you check all functions, assignments, configurations, and model mixes. A list of new features is always released with the firmware update.

9.3 Sounds, Alarms & Acoustic Updates

At this time, the JETI firmware supports *.wav sound files. Any sound file can be assigned to any function, switch, flight mode, telemetry alarm, or music routine. Your applications are limited only by your imagination. All sounds must be copied to the "Audio" file.

9.4 System Backup

Data backup is as easy as the standard backup you can perform on your PC. You can save all your data onto a PC hard drive or CD. The saved data will, of course, reflect your last transmitter configuration and model settings. The data recovery is as easy as copying your backed up files back to the transmitter. This backup can be done automatically via Jeti Studio.

9.5 PC Joystick

DS-12 transmitters can be very simply used as a joystick interface for your PC. Connect your transmitter to a PC with the USB cable. Your operating system will identify the transmitter as an HID (Human Interface Device) gaming device.

9.6 Telemetry Data Logging

All telemetry data is stored on the internal SD card in the "Log" directory file. Telemetry data files are easily identifiable as .log files. The data files use date stamps with the "year/month/day" configuration. Flight logs can be viewed on the PC using the JETI "Flight Monitor" software.

9.7 Copying models between the transmitters

Configuration of all models in the transmitter are stored on the internal **SD card** in the directory **/Model/**. When you copy the selected model from one transmitter to another, simply copy the *.**jsn** file again to the **/Model/** directory of the second transmitter.

Note: It is important that the two transmitters may not have the same software equipment, so it is possible that the configuration of the activated modules will not match each other. In this case it is necessary to check the individual functions of the model, since an attempt to load the model by another transmitter may end up with error message.

10 Battery Safety Handling Rules

10.1 Transmitter Battery Pack

1. The Installed battery pack must be charged from an AC voltage source using only the included wall battery charger. The included adapters work with local utility services, each country might be supplied with a different type of charger.

EU: SYS1428-2412-W2E

UK: SYS1428-2412-W3U

US: SYS1428-2412-W2

Do not use any battery other than the manufacturer approved Power Ion 3200DC battery pack.

2. Always verify the correct polarity while connecting a transmitter battery pack. The red lead is positive "+" and the black lead is negative "-" polarity.

3. Never test a battery pack by shorting the wire leads. Do not allow the battery to overheat at any time.

4. Never leave your transmitter unattended at any time while it is being charged.

5. Never charge an overheated battery pack, or in an environment warmer than 158 F (70C).

6. During cold months always check the battery's capacity, do not rely on your radio's low battery warning system.

7. Always check your transmitter and receiver batteries prior each flight. Do not rely on your radio's low battery warning system.

8. Do not allow radio battery pack to come in contact with open flame, other heat source or moisture at any time.

10.2 General Safety Rules

1. Any repair, installation, or upgrade must be performed with caution and common sense. These will require some basic mechanical skills.



2. For any of the upgrades which require removing the radio back cover you MUST disconnect the transmitter battery pack before attempting any work.

3. It is imperative to store your radio in a controlled environment. Any extreme temperatures can cause damage to the sensitive electronics. A sudden change in temperature or humidity can create condensation which can permanently damage your radio.

4. Do not use radio during poor weather conditions. Any water or condensation can cause corrosion and could permanently disable your radio. If you suspect that moisture has entered your transmitter, turn it OFF, remove the back cover and let dry it out.

5. Avoid use in dusty environments.

6. The manufacturer is not responsible for any unauthorized modifications. Changes or modifications not expressly approved by the party responsible for compliance will void the user's authority to operate the equipment.

7. This is a sophisticated hobby product and not a toy. It must be operated with caution and common sense, always avoid any mechanical damage.

8. Always avoid operating close to devices that might cause harmful electromagnetic interferences.

9. Keep all moving parts clean and free of dust or fine debris that might damage the mechanical parts of the radio.

10. Do not point the transmitter antenna directly towards your model or a human body. The radiation pattern from the antenna will be shielded and provide poor connection to your model.
11. Never repair, re-install, or exchange the internal memory SD card for other type.
12. Avoid extreme temperatures as they can cause damage to the sensitive internal SD card.
13. Always perform a ground range check prior to your initial flight.

10.3 Flight Safety Check

1. Always verify the correct position of the switches, and the gimbals, prior turning ON your transmitter. Turn on the transmitter first, then receiver. JETI transmitters use **"Model Checking"**. This safety is designed so that the model memory stores the unique serial number of the receiver that has already been assigned to model. When the transmitter establishes communication with the receiver and the serial number does not match the number stored in the current model's setup, the transmitter displays a warning. You will then be able to accept the change or reject the change. If you accept the change, the transmitter stores the new receiver number into the model's setup and begins transmitting. If you reject the change, the transmitter will not communicate with the receiver and you will be allowed to select another model.
2. Perform a ground range check before each day's flying session.
3. Check the battery voltage on both the transmitter and the receiver battery packs.
4. Check all channel assignments, trim, mixes, and the correct

direction of movement for your flight surfaces.

5. Set motor/engine kill switch and test the power train.

10.4 Application

This product may be used for model airplane or surface (boat, car, robot) use only. It is not intended for use in any other application than control of the models for hobby, sport and recreational purposes.

10.5 FCC /IC information

This equipment has been tested and found to comply with the limits for a Class B digital device, pursuant to Part 15 of the FCC Rules. These limits are designed to provide reasonable protection against harmful interference in a residential installation. This equipment generates, uses, and can radiate radio frequency energy and, if not installed and used in accordance with the instructions, may cause harmful interference to radio communications. However, there is no guarantee that interference will not occur in a particular installation. If this equipment does cause harmful interference to radio or television reception, which can be determined by turning the equipment off and on, the user is encouraged to try to correct the interference by one or more of the following measures:

- Reorient or relocate the receiving antenna.
- Increase the separation between the equipment and receiver.
- Connect the equipment into an outlet on a circuit different from that to which the receiver is connected.
- Consult the dealer or an experienced radio/TV technician for help.

THIS DEVICE COMPLIES WITH PART 15 OF THE FCC RULES. OPERATION IS SUBJECT TO THE FOLLOWING TWO CONDITIONS (1) THIS DEVICE MAY NOT CAUSE HARMFUL INTERFERENCE, AND (2) THIS DEVICE MUST ACCEPT ANY INTERFERENCE RECEIVED, INCLUDING INTERFERENCE THAT MAY CAUSE UNDESIRE OPERATION.

Warning: Changes or modifications to this device not expressly approved by Esprit Model/JETI USA could void the user's authority to operate the equipment. "This equipment complies with FCC radiation exposure limits set forth for an uncontrolled environment. This equipment is in direct contact with the body of the user under normal operating conditions. This transmitter must not be co-located or operating in conjunction with any other antenna or transmitter."

Under Industry Canada regulations, this radio transmitter may only operate using an antenna of a type and maximum (or lesser) gain approved for the transmitter by Industry Canada. To reduce potential radio interference to other users, the antenna type and its gain should be so chosen that the equivalent isotropically radiated power (e.i.r.p.) is not more than that necessary for successful communication.

Conformément à la réglementation d'Industrie Canada, le présent émetteur radio peut fonctionner avec une antenne d'un type et d'un gain maximal (ou inférieur) approuvé pour l'émetteur par Industrie Canada. Dans le but de réduire les risques de brouillage

radioélectrique à l'intention des autres utilisateurs, il faut choisir le type d'antenne et son gain de sorte que la puissance isotroperayonnée équivalente (p.i.r.e.) ne dépasse pas l'intensité nécessaire à l'établissement d'une communication satisfaisante.

This device complies with the Industry Canada license-exempt RSS standard(s). Operation is subject to the following two conditions: (1) this device may not cause interference, and (2) this device must accept any interference, including interference that may cause undesired operation of the device.

Le présent appareil est conforme aux CNR d'Industrie Canada applicables aux appareils radio exempts de licence. L'exploitation est autorisée aux deux conditions suivantes :

(1) l'appareil ne doit pas produire de brouillage, et (2) l'utilisateur de l'appareil doit accepter tout brouillage radioélectrique subi, même si le brouillage est susceptible d'en compromettre le fonctionnement.

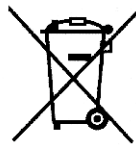
**ENGLISH****Information on Disposal for Users of Waste Electrical & Electronic Equipment (private households)**

This symbol on the products and/or accompanying documents means that used electrical and electronic products should not be mixed with general household waste.

For proper treatment, recovery and recycling, please take these products to designated collection points, where they will be accepted on a free of charge basis. Alternatively, in some countries you may be able to return your products to your local retailer upon the purchase of an equivalent new product.

Disposing of this product correctly will help to save valuable resources and prevent any potential negative effects on human health and the environment which could otherwise arise from inappropriate waste handling. Please contact your local authority for further details of your nearest designated collection point.

Penalties may be applicable for incorrect disposal of this waste, in accordance with national legislation.

For business users in the European Union

If you wish to discard electrical and electronic equipment, please contact your dealer or supplier for further information.

Information on Disposal in other Countries outside the European Union

This symbol is only valid in the European Union.

If you wish to discard this product, please contact your local authorities or dealer and ask for the correct method of disposal.



Declaration of Conformity

in accordance with the regulations of EU Directive
RED 2014/53/EU and RoHS 2011/65/EU.
This declaration of conformity is issued under the sole responsibility of the manufacturer.

Producer: JETI model s.r.o.
Lomená 1530, 742 58 Příbor, Česká republika
IC 26825147

declares, that the product

Type designation: transmitter DUPLEX EX
Model number: DS-12

Frequency band 1: 2400,0 – 2483,5 MHz
Max power band1: 100 mW e.i.r.p

Frequency band 2: 863,0 – 870,0 MHz
Max power band 2: 25 mW e.i.r.p.

58

The stated product complies with essential requirements of
RED Directive 2014/53/EU and RoHS Directive 2011/65/EU.

Harmonised standards applies:

Measures for the efficient use of the radio frequency spectrum [3.2]

EN 300 328 V 2.2.2
EN 300 220-2 V 3.1.1

Protection requirements concerning electromagnetic compatibility [3.1(b)]

EN 301 489-1 V 2.1.1
EN 301 489-3 V 2.1.1
EN 301 489-17 V 3.1.1

Electrical Safety and Health [3.1(a)]

EN 62368-1:2015
EN 62479:2010

RoHS EN 50581:2012

Příbor, 11.5.2021

Ing. Stanislav Jelen,
Managing Director

duplex 



JETI model s.r.o.

Lomená 1530, 742 58 Příbor

www.jetimodel.com

Made in Czech Republic

