

**Weekender**  
by **HITEC**

# Zipper

**OPERATION MANUAL Ver 1.0**

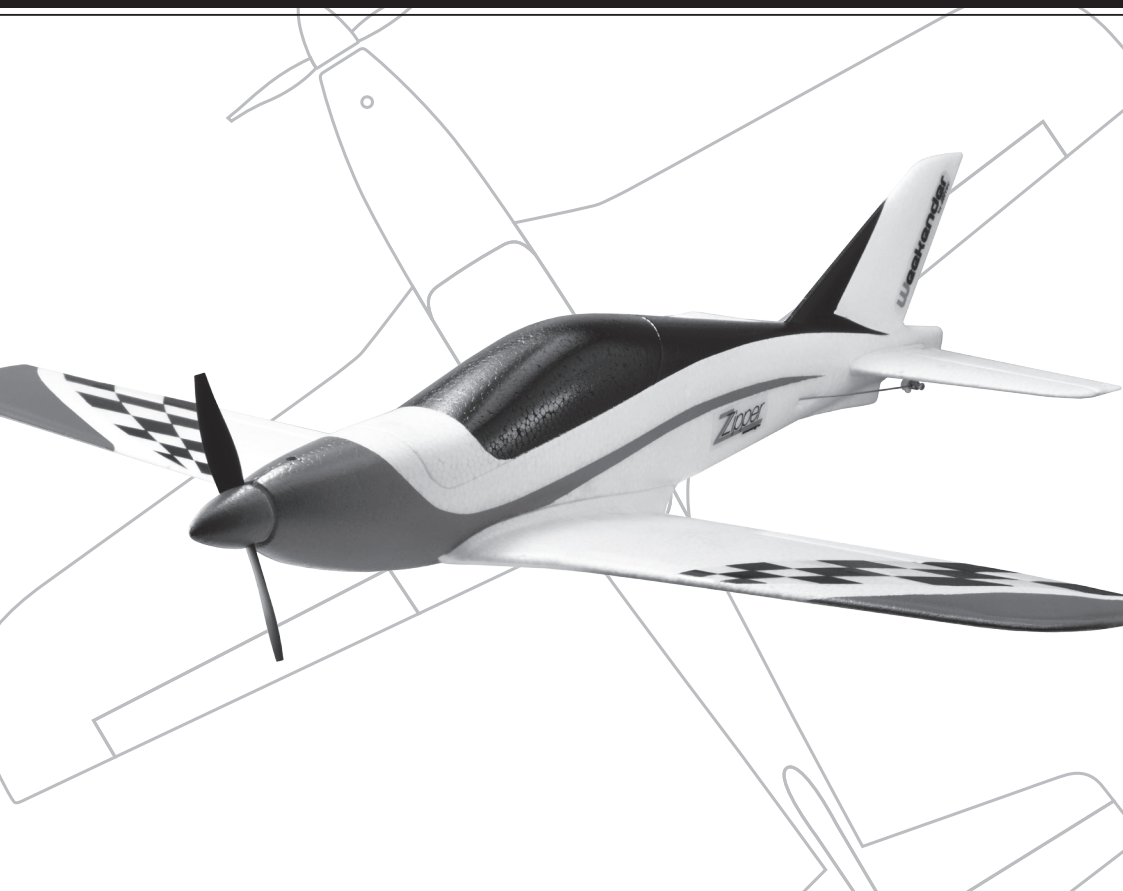

[www.hitecrd.com](http://www.hitecrd.com)

# TABLE OF CONTENTS

Section 1	
Introduction.....	2
Warnings and Safety Instructions .....	3
Features and Specifications .....	3
Items Required to Ready This Model for Flight .....	3
Parts Layout and Listing .....	4
Section 2	
Assembly Instructions.....	4
Section 3	
Preparing for Flight .....	6
• Speed Control Operation.....	6
• Flying Your Plane.....	6
Section 4	
Spare Parts .....	6
Service and Support .....	7
Warranty.....	7

## SECTION 1

### INTRODUCTION

Thank you for purchasing the Weekender Zipper radio control airplane. With its durable EPO foam construction and aileron/elevator three-channel control, this sporty aerobatic plane is a great fit for novice/intermediate pilots. The preinstalled brushless motor, speed control and servos will have you in the air in a flash. Zip through the skies with the agile Zipper!



Caution

The Weekender Zipper is a radio control model plane designed for novice/intermediate pilots over the age of 14. User negligence or improper assembly can lead to serious injury and/or property damage to yourself or others. Weekender is not responsible for any damages or injuries caused by the user's negligence or improper assembly of the model. Be sure to read the instruction manual thoroughly before assembling and flying the model.



Caution

Safety is of the utmost importance when flying any model aircraft. Third party insurance is mandatory. If you join a model club or association, suitable coverage will usually be available through the organization. It is your personal responsibility to ensure that your insurance is adequate (i.e. that its coverage includes powered model aircraft). Always fly in such a way that you do not endanger yourself or others. Bear in mind that even the best RC systems are subject to outside interference. No matter how many years of accident-free flying you have, there is always the possibility of an unforeseen problem or error that can cause an accident. Make it your job to keep your models and your radio control system in perfect operating condition at all times. Check and observe the correct charging procedure for the batteries you are using. **Before every flight, check that the wings and the tail panels are attached and firmly seated. Also check to make sure that each control surface is operating correctly.**



Warning

## Flying Your Aircraft

- You should only fly at an official model airfield.
- Check that other pilots and spectators are positioned safely before flying your model.
- Wait for other pilots to land their models if they are flying already.
- Do not fly the plane behind yourself or others.
- Do not fly under the influence of alcohol or drugs or if you are feeling ill.
- Do not fly during thunderstorms or high wind.
- Do not fly in an area where people are gathered or near tall buildings.
- Do not fly near streets or where vehicles or trains pass by.
- Do not fly near explosive materials.
- Do not fly near power lines or transmission towers.
- Be sure to do pre-flight safety checks of the model before flying.
- Always remember that the pilot is responsible for any outcome that may occur during the flight.



Caution



Tip

## FEATURES AND SPECIFICATIONS

### Features

- Durable pre-painted EPO airframe, easily assembled in less than 45 minutes
- Powerful preinstalled brushless outrunner motor and 10-amp ESC
- Preinstalled nano servos
- Removable canopy for easy access to motor and ESC
- 6+ minute runtimes with recommended battery

### Specifications

- **Wingspan:** 23.6 in (600 mm)
- **Length:** 21.3 in (541 mm)
- **Weight:** 5.3 oz (150 g)
- **Wing Area:** 93 sq in (6 dm<sup>2</sup>)
- **Wing Loading:** 8.2 oz/sq ft (25 g/dm<sup>2</sup>)

## ITEMS REQUIRED TO READY THIS MODEL FOR FLIGHT



The Weekender Zipper is a Plug and Play-type model where additional items are required for operation. The items listed below are needed to fly:

- 6-Channel Radio and Receiver
- 2 - 3S, 7.4 ~ 11.1V, 400 ~ 500 mAh LiPo battery
- Charger Suitable for the Battery Above

## MODEL FINISHING

The Zipper comes unfinished but can easily be painted with commercially available enamel paints. When painting, you should use multiple light coats to avoid damaging the foam or adding too much weight.

## PARTS LAYOUT AND LISTING



### Note

Note: Before assembly, it is important that you remove the parts from the packaging and check to make sure that all the parts are included and that they are in good condition.

- A. Fuselage Assembly (includes installed Motor, ESC and Elevator Servo)
- B. Main Wing
- C. Horizontal Stabilizer
- D. 2x Spinner
- E. Small Parts Package, Includes:
  - i. Propeller
  - ii. 1 piece 2.0 x 16mm screw for wing
  - iii. 1 piece double sided tape for mounting receiver
  - iv. 1 piece Velcro hook and loop for mounting battery

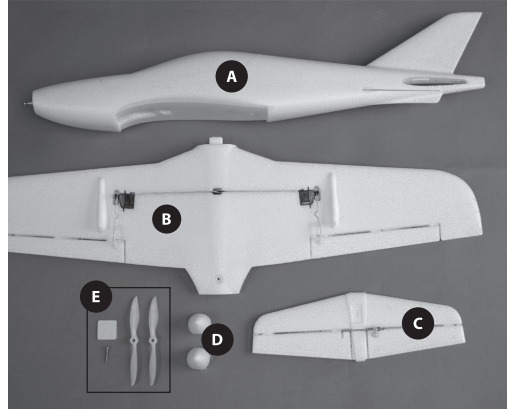

## SECTION 2

### ASSEMBLY INSTRUCTIONS

#### Tools Required for Assembly

- #1 Phillips Head Screwdriver
- Razor Knife



#### Step 1: Horizontal Stabilizer Assembly

Slide the horizontal stabilizer through the fuselage until it locks into place. Slide the elevator linkage into the swivel and tighten the screw.



### Note

While not necessary, you can apply a small amount of CA glue to hold the pieces permanently in place.

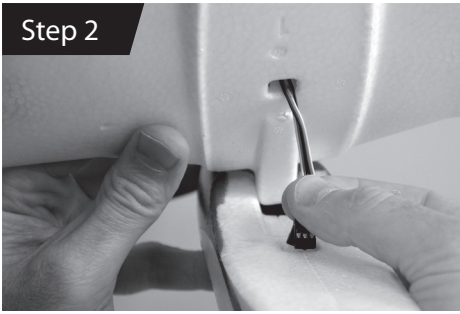

### Step 2: Main Wing Assembly

Install the wing by sliding the tab on the front of the wing into the fuselage while guiding the servo leads through the hole. Insert the 2.0 x 16mm screw and tighten until snug.

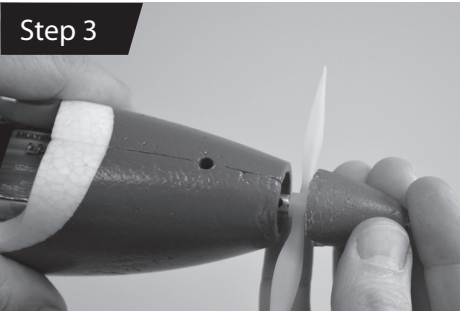
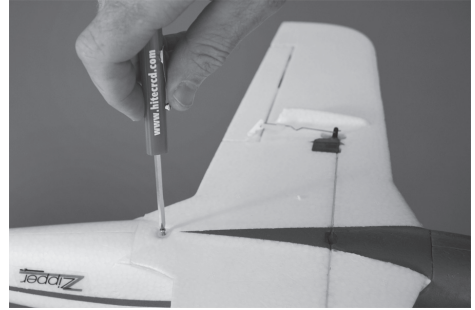
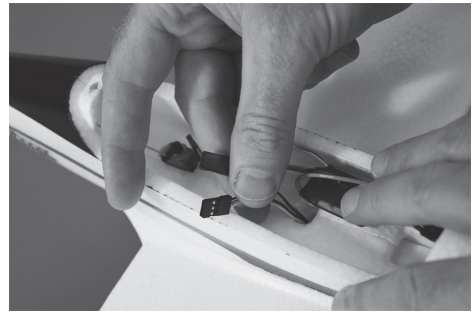

### Step 3: Spinner Assembly

Place the foam spinner over the propeller.



Note

While not necessary, you can apply a small amount of CA glue to hold the pieces permanently in place.

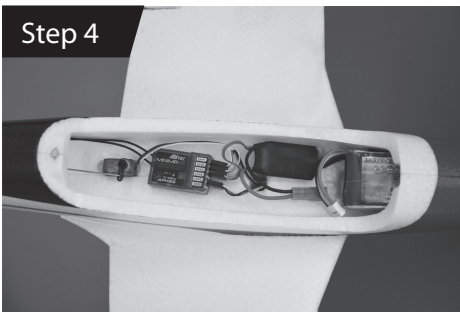

### Step 4: Receiver and Battery Installation

Using the double sided tape, install the receiver into the fuselage and plug the servo and ESC leads into the appropriate channels. Using the included Velcro strip, install the battery into the front of the fuselage.

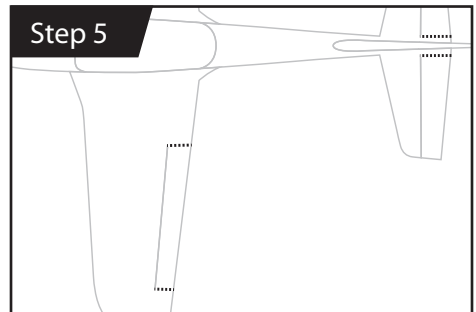

### Step 5: Cutting the Control Surfaces

Before flying, you will need to cut the control surface so they can move freely. Using a sharp razor knife, cut only where indicated with dashed lines in the above illustration.

## Step 6

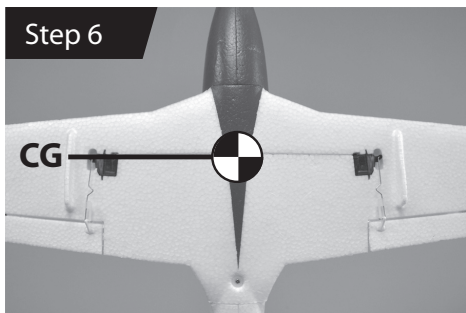

## Step 6: Balancing Your Model

Check the center of gravity (CG) on your model by balancing it on your fingers. The CG should be at about the same place as the servo leads on the bottom of the wing. You can adjust the CG by moving the battery forward or backwards.

# SECTION 3

## PREPARING FOR FLIGHT

### Speed Control Operation

The ESC is set for optimal performance at the factory and should not be changed. Before connecting the battery, make sure the throttle is in the lowest (off) position. If the throttle is not in the lowest, off position, the speed control will not initialize. If this happens, you will need to disconnect the battery and repeat the initialization sequence.

### Flying Your Plane

Before taking off, perform a radio range check and make sure all your control surfaces are operating in the proper direction. Take off into the wind and climb to 50 feet to begin your trim out procedures. Once trimmed out, feel free to test the performance of the plane by performing a variety of aerobatic maneuvers.

# SECTION 4

## SPARE PARTS

59005

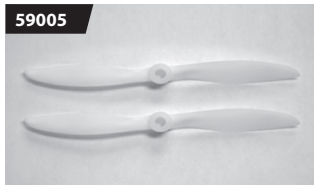

Propeller x2

59006

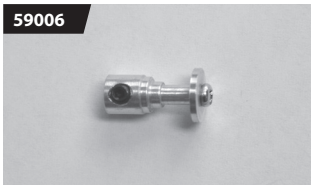

Propeller Hub

59007

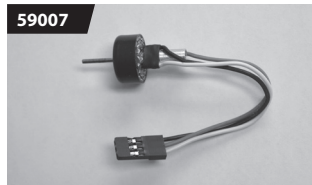

Motor

59008

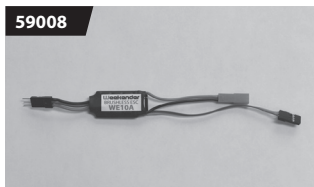

ESC

59004



Servo

59010



Foam Spinner\ x2

### **Weekender by Hitec Customer Service**

Help is available from Hitec RCD USA, Inc. Customer Service through phone support: (858) 748-6948 and e-mail: [service@hitecrcd.com](mailto:service@hitecrcd.com). Our office is generally open Monday through Friday, 8:00 AM to 4:30 PM PST. These hours and days may vary by season. Every attempt is made to answer all incoming service calls. Should you get our voice mail, please leave your name and number and a staff member will return your call.

### **LIMITED WARRANTY**

Weekender by Hitec guarantees the component parts in this kit to be free from defects in both materials and workmanship that exist at the time of purchase for a period of 90 days from the date of purchase. If any component part fails to function because of defects in materials or workmanship during this period, the manufacturer's obligations are limited, at its discretion, to either, repair or replace the defective part.

This warranty does not cover any component part that has been damaged through use, modification, misuse, abuse, accident or neglect; nor does it cover normal wear and tear. Additionally, this warranty is void if the component part has been altered or modified or repaired by anyone other than Hitec RCD USA, Inc. or its authorized agents.

Hitec RCD USA, Inc. is not responsible for loss of use of the Weekender by Hitec model, or other incidental or consequential damages. Under no circumstances shall the Manufacturer or any of its representatives be held liable for injury to persons or property damage resulting from the assembly of the product or from the use of the final user assembled product. Furthermore, no liability shall be attached to Weekender by Hitec or Hitec RCD USA, Inc. from the use of the final assembled product because: the product operates and is controlled by way of remote radio frequency; and outside radio frequencies may interfere with the product frequency, causing loss of control. Because an out-of-control model has the potential to cause personal injury and property damage, Weekender by Hitec or Hitec RCD USA, Inc. cannot be held liable for personal injury or property damage caused by the use or misuse of Weekender by Hitec model products. By the act of using the user-assembled products, the user accepts all resulting liability. Some states do not allow exclusion of incidental or consequential damages, so the above limitations and exclusion may not apply to you.

Weekender by Hitec and Hitec RCD USA, Inc. hereby exclude any and all express warranties not specifically stated herein and all implied warranties of merchantability and fitness for a particular purpose. There are no warranties which extend beyond the description of the warranties contained within this document.

### **What to Return**

Return only the component part that is defective in materials or workmanship. Please pack the unit carefully and insure it, as this warranty does not cover loss or damage in transit.

Hitec RCD USA, Inc.  
12115 Paine St.  
Poway CA, 92064  
(858) 748-6948

**Weekender**  
by **HITEC**

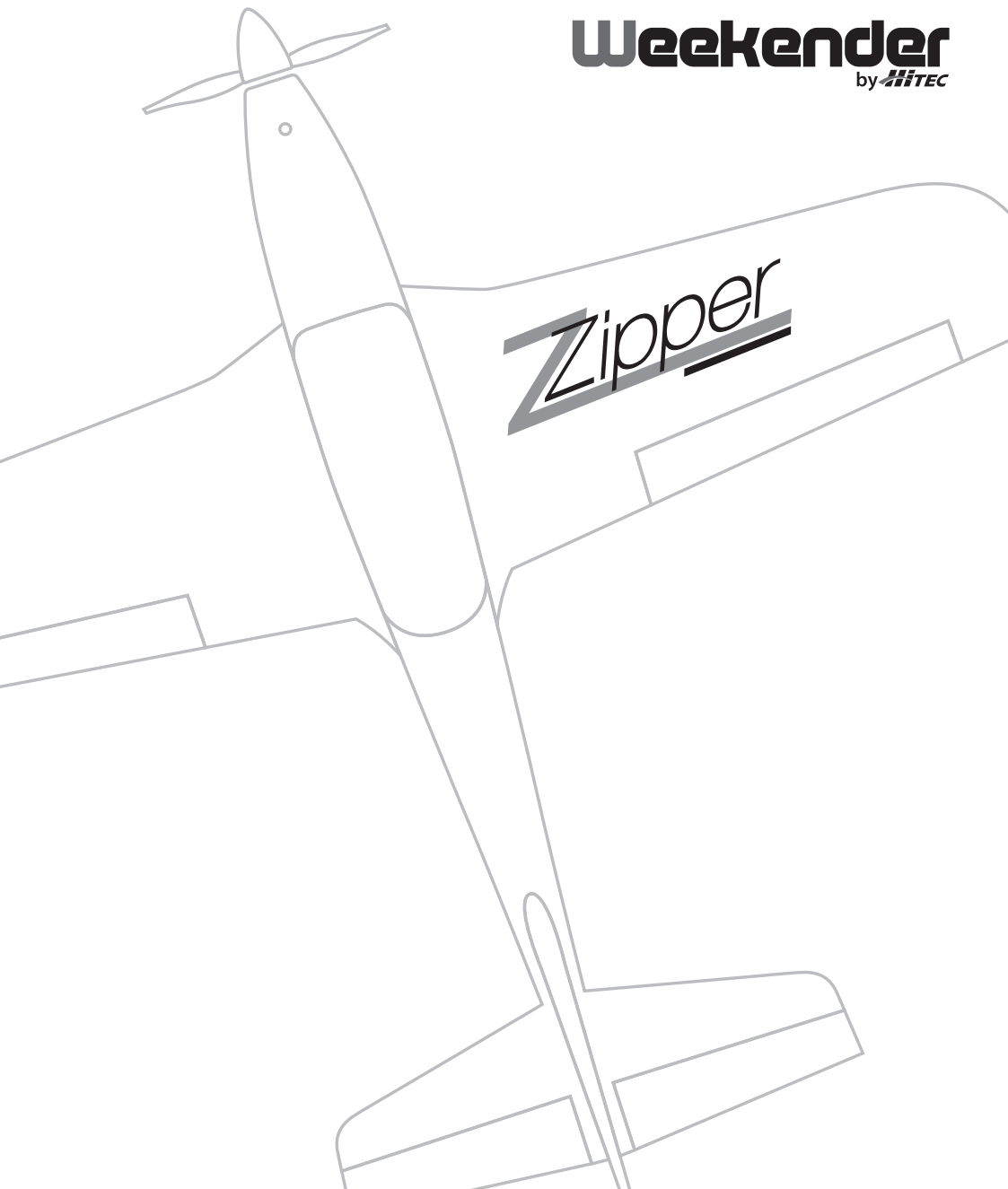

[www.hitecrd.com](http://www.hitecrd.com)



MADE IN CHINA